

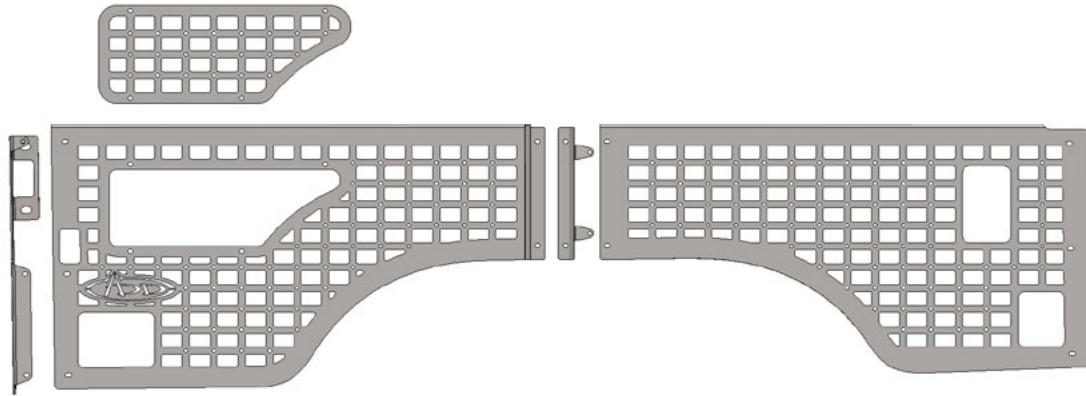

# INSTALLATION GUIDE

## 2019-UP/RAM 2500 BED SIDE MOLLE PASSENGER SIDE AC5603301NA



### TOOLS REQUIRED

- (Allen) 5/32
- (Drill Bit) 25/64
- Ratchet
- Drill
- Marker
- Rivet Nut Hand Tool



### TIME REQUIRED

30 Minutes



### SKILL LEVEL

Level 2 | Easy

## ⚠️ WARNINGS/CAUTIONS BEFORE STARTING INSTALLATION ⚠️

-BEFORE YOU INSTALL THIS KIT-

**Read and understand all instructions,** warnings, cautions, & notes contained in this installation instruction guide. Consult your vehicle owner's manual for proper disconnection of electrical and lifting of vehicle if required for installation of this product.

This install may require some technical skills and knowledge of basic mechanical work. If you do not feel that you are capable of performing this install please take this product to a trained professional.

After reading this guide please contact us with any questions or concerns before installing product.

Customer Service (480) 671-0820

Addictive desert designs is not responsible for any bodily injury or harm to you or your vehicle as a result of an improper install.

Proper installation of this kit required knowledge of the factory recommended procedures for removal and installation of original equipment components.

We recommend that the factory shop manual and any special tools needed to service your vehicle be on hand during the installation. Installation of this kit without proper knowledge of the factory recommended procedures may affect the performance of these

components and the safety of the vehicle. Inspect all contents of this package to make sure product is not damaged and all installation hardware has been included. If parts are missing from kit, please be prepared to provide the following information:

1. Name of purchase location
2. Bar Code on side of box
3. Date above bar code
4. Date inside box cover

**\*ALWAYS WEAR EYE PROTECTION WHEN OPERATING POWER TOOLS\***



# INSTALLATION GUIDE

## HARDWARE/PARTS

**A.**



1/4-20 X 3/4" BUTTON HEAD BOLT

**QTY: 9**

**B.**



1/4-20 X 1 1/4" BUTTON HEAD BOLT

**QTY: 3**

**C.**



1/4-20 X 1 1/2" BUTTON HEAD BOLT

**QTY: 1**

**D.**



1/4-20 X 2 1/2" BUTTON HEAD BOLT

**QTY: 1**

**E.**



M6 WASHER

**QTY: 14**

**E1.**



M6 PUSH NUT

**QTY: 5**

**F.**

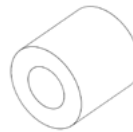

1/2" SPACER

**QTY: 3**

**F1.**



3/4" SPACER

**QTY: 1**

**F2.**

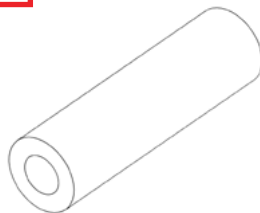

1-3/4" SPACER

**QTY: 1**

**G.**



1/4-20" RIVET NUT

**QTY: 9**

Reference this page throughout the install



# INSTALLATION GUIDE

BED SIDE MOLLE PASSENGER SIDE  
2019-UP/RAM 2500

## INSTALL

### STEP 1

Install the mounting bracket on the rear panel as shown below with the provided (A, E) 1/4 hardware using a (5/32 allen).

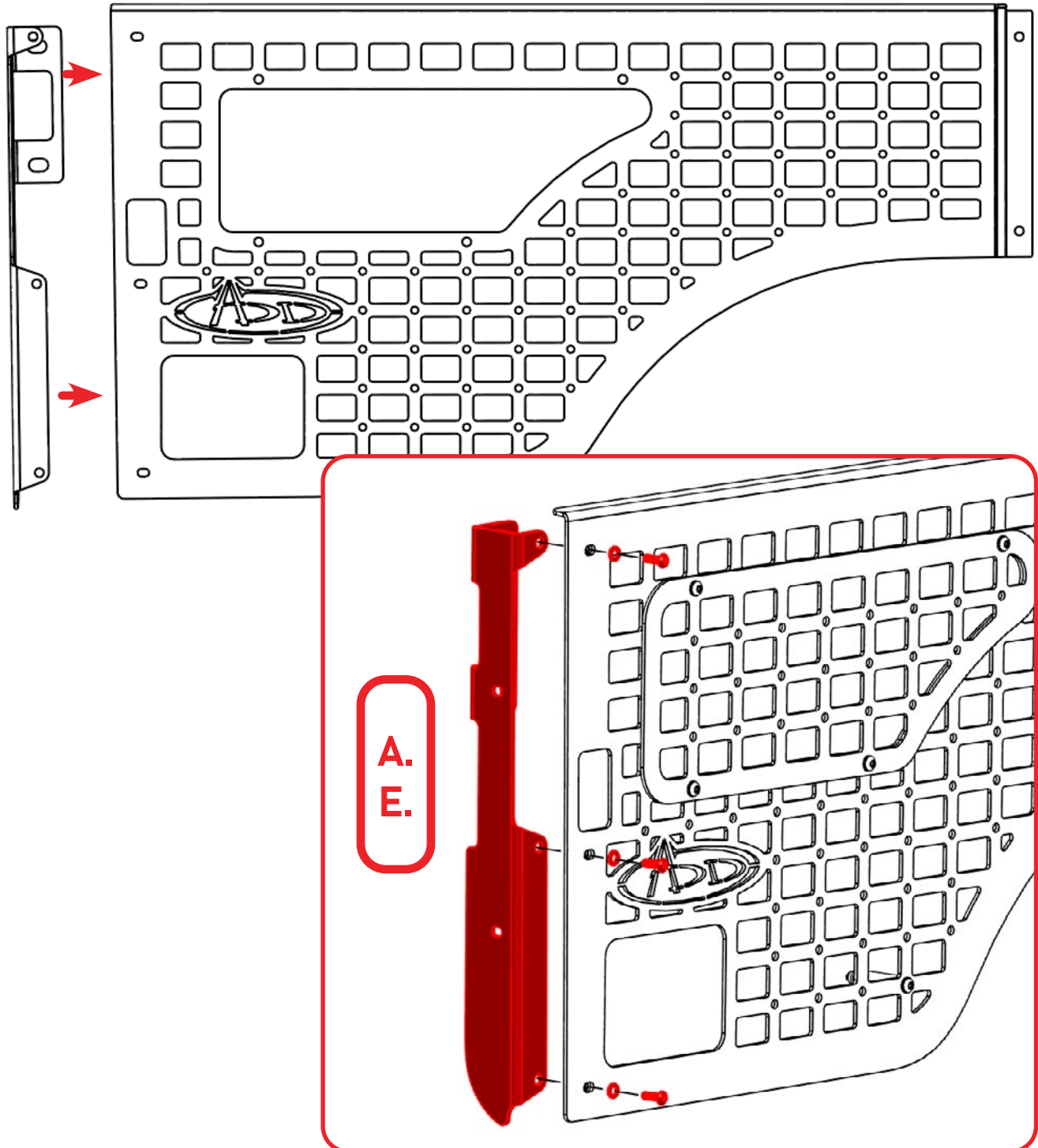



# INSTALLATION GUIDE

BED SIDE MOLLE PASSENGER SIDE  
2019-UP/RAM 2500

## INSTALL

### STEP 2

Next, Assemble the mounting bracket as shown below with the provided (A, E) 1/4 hardware.

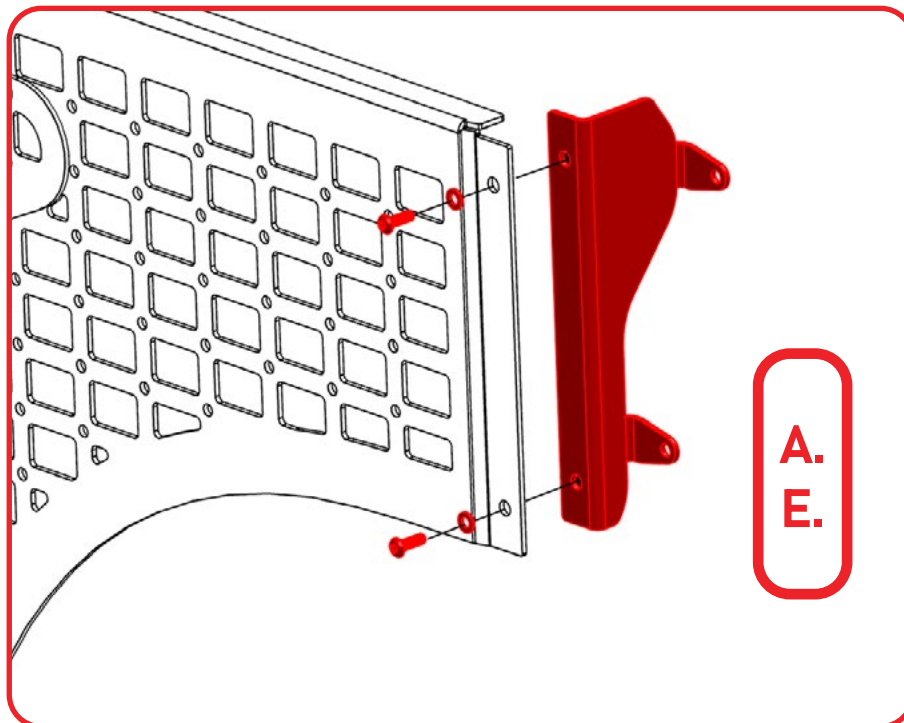
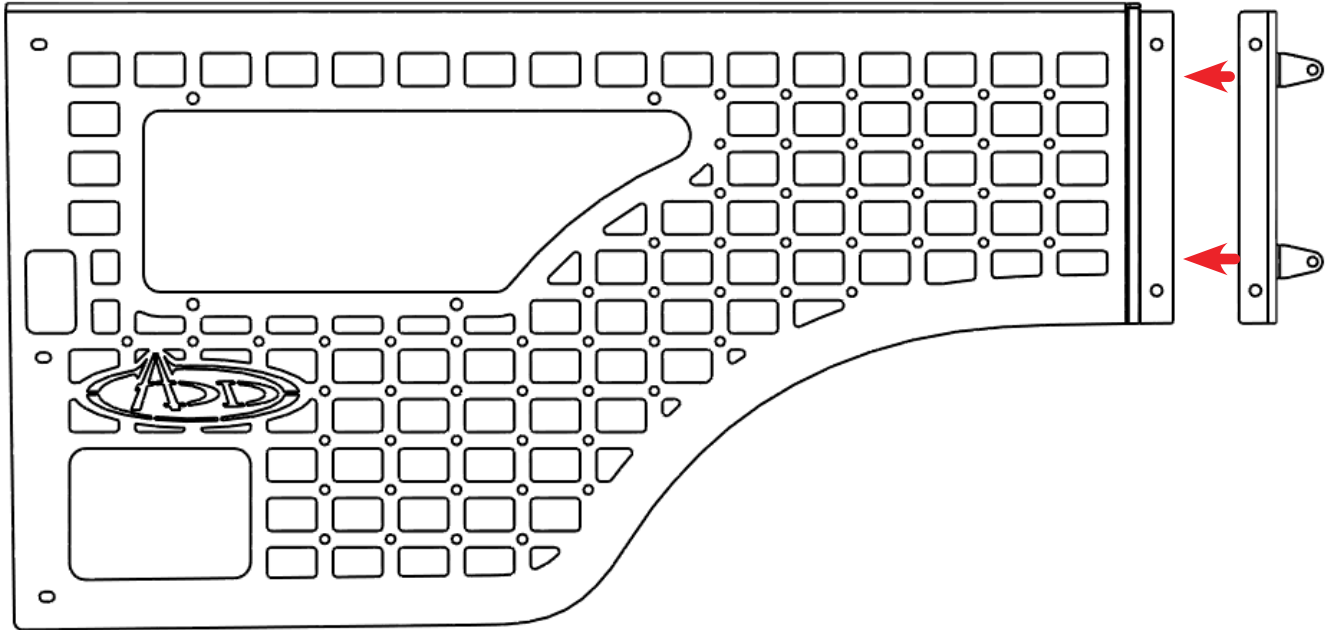

## BED SIDE MOLLE PASSENGER SIDE 2019-UP/RAM 2500

## INSTALL

### □ STEP 3

Hold the panel up with the top of the panel flush with the top of the bed. Next, mark out the 2x holes on the bracket installed on **step 1**. Remove panel and set aside.

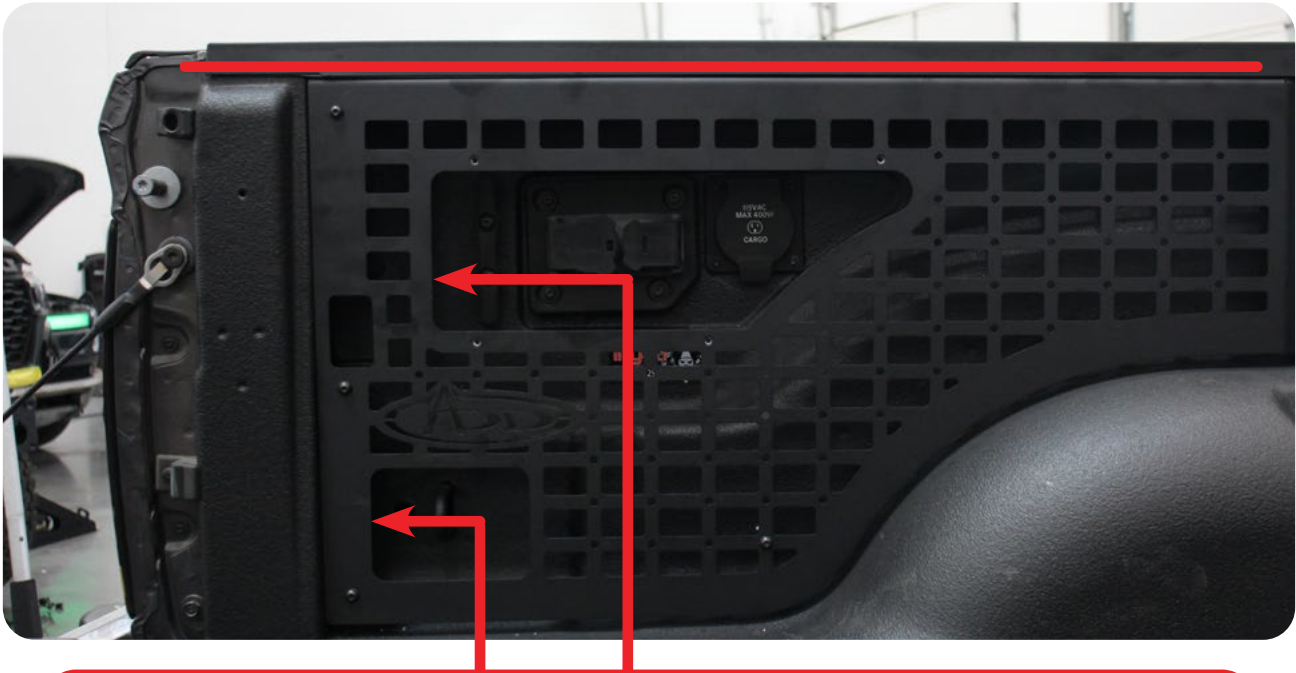

## BED SIDE MOLLE PASSENGER SIDE 2019-UP/RAM 2500

## INSTALL

### □ STEP 4

Using a (25/64 drill bit) Drill the mounting holes marked on **step 3**. Next, install the provided **(G)** 1/4 rivet nut using a (rivet nut hand tool).

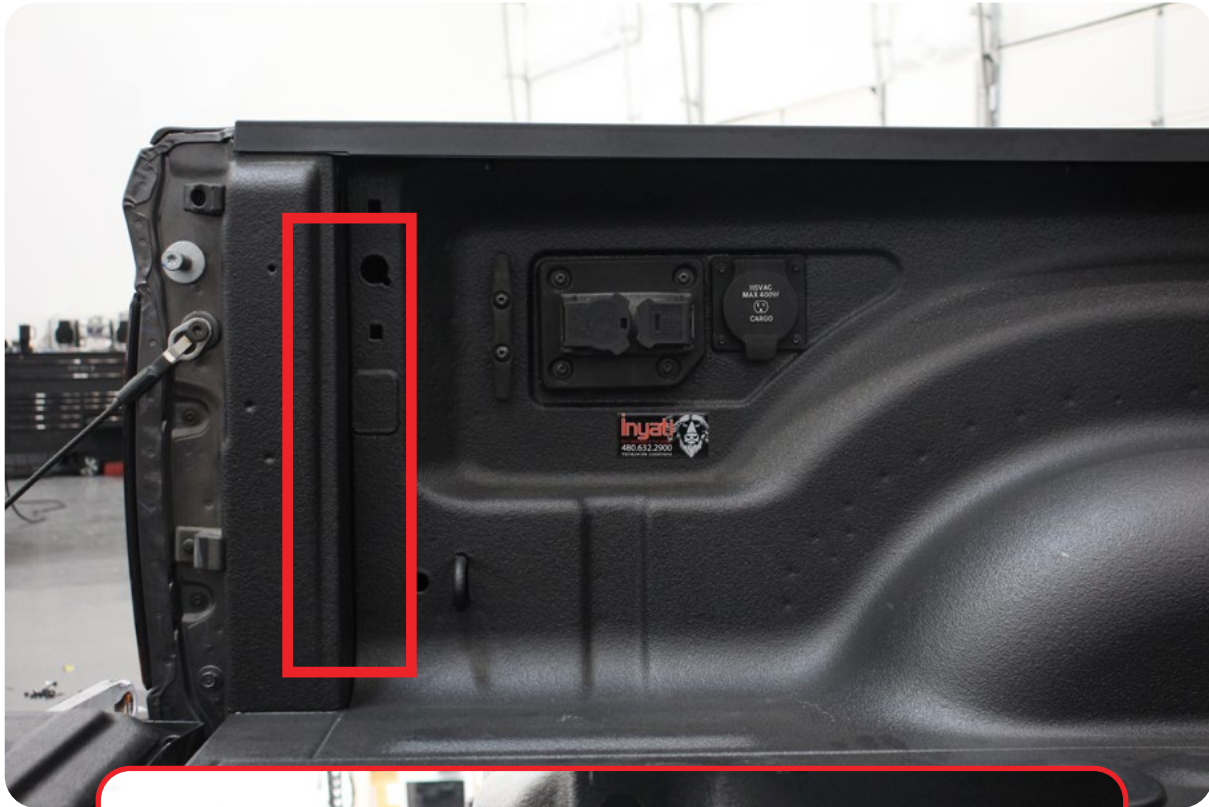

## BED SIDE MOLLE PASSENGER SIDE 2019-UP/RAM 2500

## INSTALL

### □ STEP 5

Re-Install the rear panel and install the provided (A, E) 1/4 hardware using a (5/32 allen) into the rivet nuts from step 4.

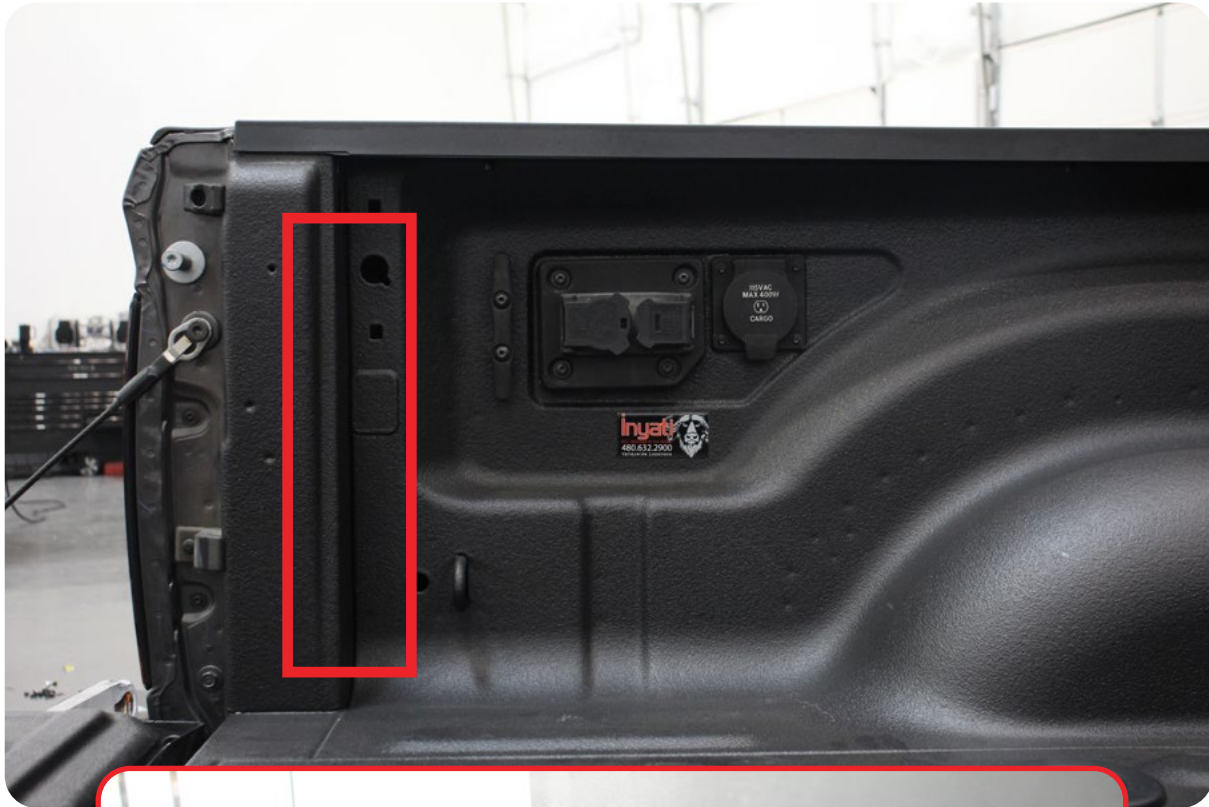

## BED SIDE MOLLE PASSENGER SIDE 2019-UP/RAM 2500

## INSTALL

### STEP 6

Re-install the rear panel using a (5/32 allen).

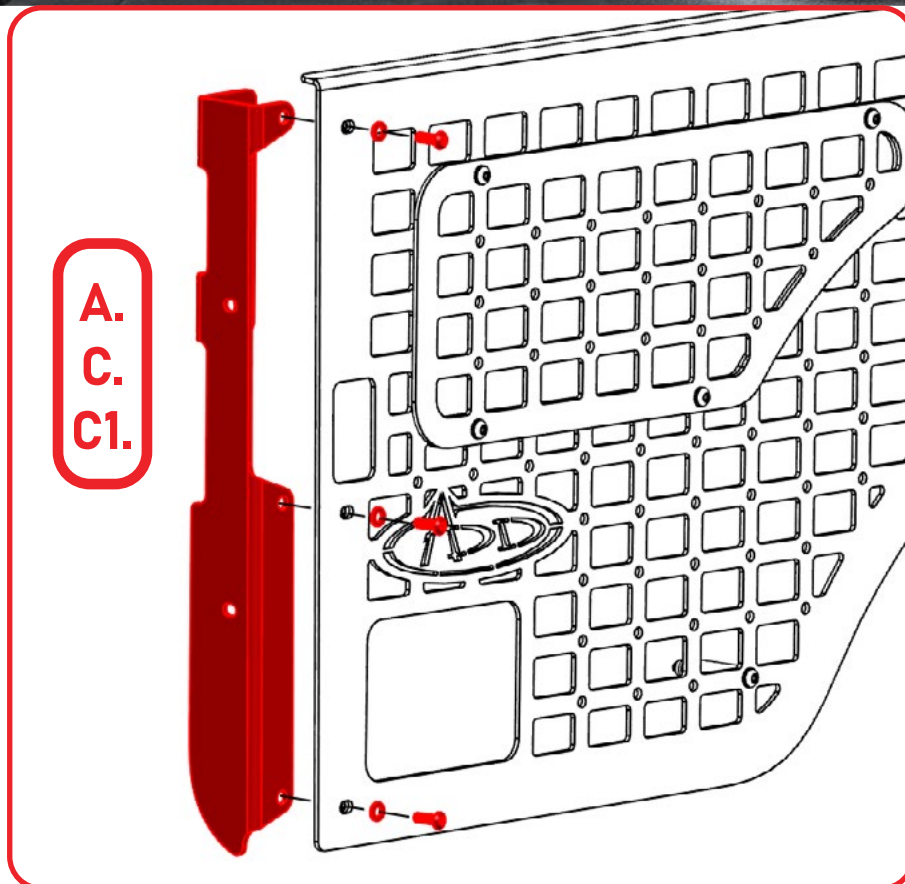



## BED SIDE MOLLE PASSENGER SIDE 2019-UP/RAM 2500

## INSTALL

### □ STEP 7

Mark the mounting holes located in the middle. Then, remove the molle panel and set aside.

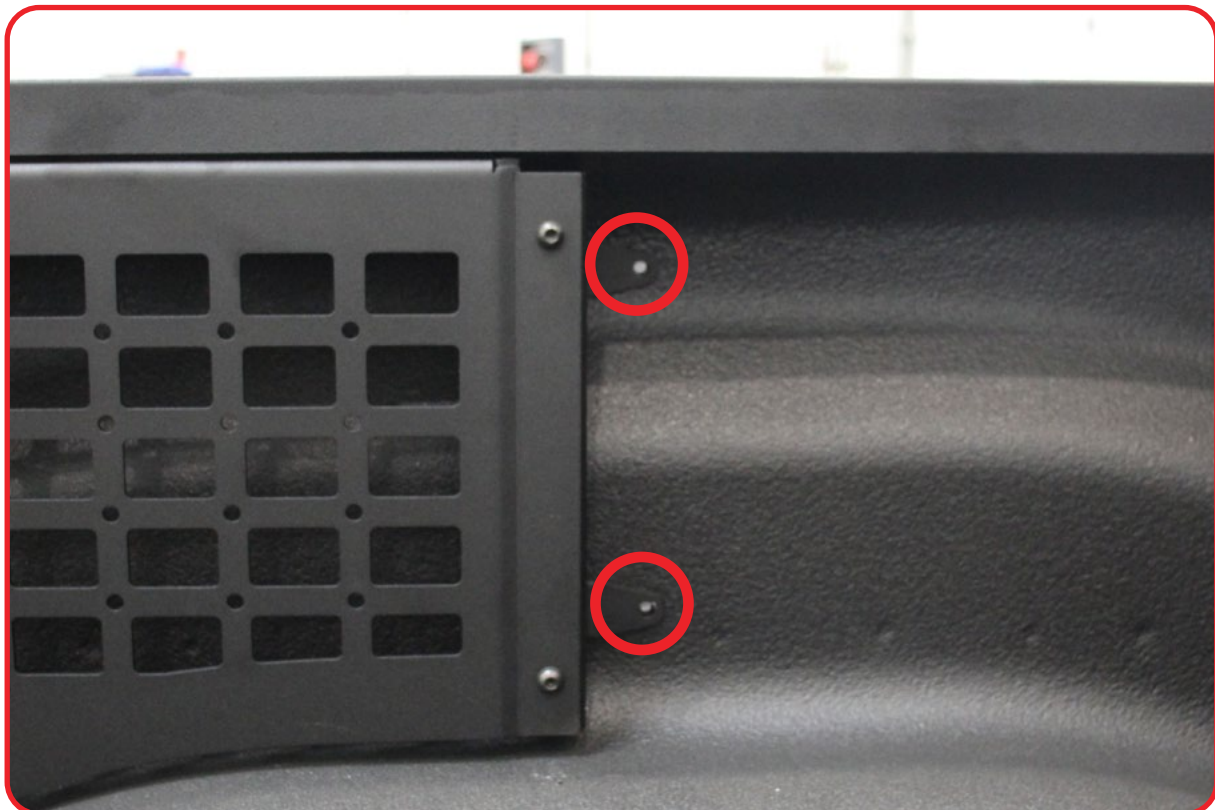



# INSTALLATION GUIDE

## BED SIDE MOLLE PASSENGER SIDE 2019-UP/RAM 2500

## INSTALL

### □ STEP 8

Using a (25/64 drill bit) Drill the mounting holes marked on **step 7**. Next, install the provided **(G)** 1/4 rivet nut using a (rivet nut hand tool).





# INSTALLATION GUIDE

## BED SIDE MOLLE PASSENGER SIDE 2019-UP/RAM 2500

## INSTALL

### □ STEP 9

Re-Install the rear panel and install the provided (A, E) 1/4 hardware using a (5/32 allen) into the rivet nuts from step 8.

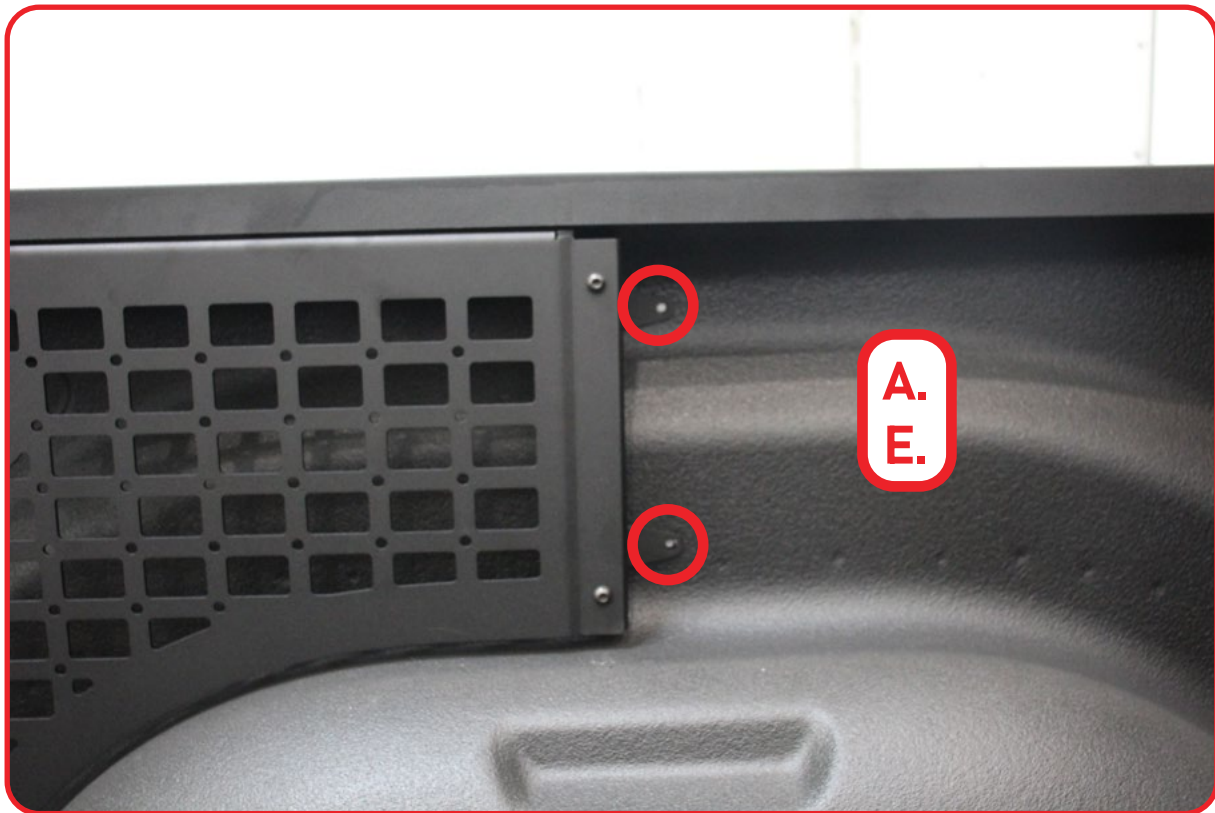

## BED SIDE MOLLE PASSENGER SIDE 2019-UP/RAM 2500

## INSTALL

### STEP 10

Mark the bottom hole on the rear panel near the wheel well as shown below. Remove panel and set aside.



## BED SIDE MOLLE PASSENGER SIDE 2019-UP/RAM 2500

## INSTALL

### □ STEP 11

Using a (25/64 drill bit) Drill the mounting holes marked on **step 10**. Next, install the provided **(G)** 1/4 rivet nut using a (rivet nut hand tool).





# INSTALLATION GUIDE

BED SIDE MOLLE PASSENGER SIDE  
2019-UP/RAM 2500

## INSTALL

### STEP 12

Install the provided (D, E, F2, E1) 1/4 bolt, washer, 1-3/4 spacer, and push nut in the order described.

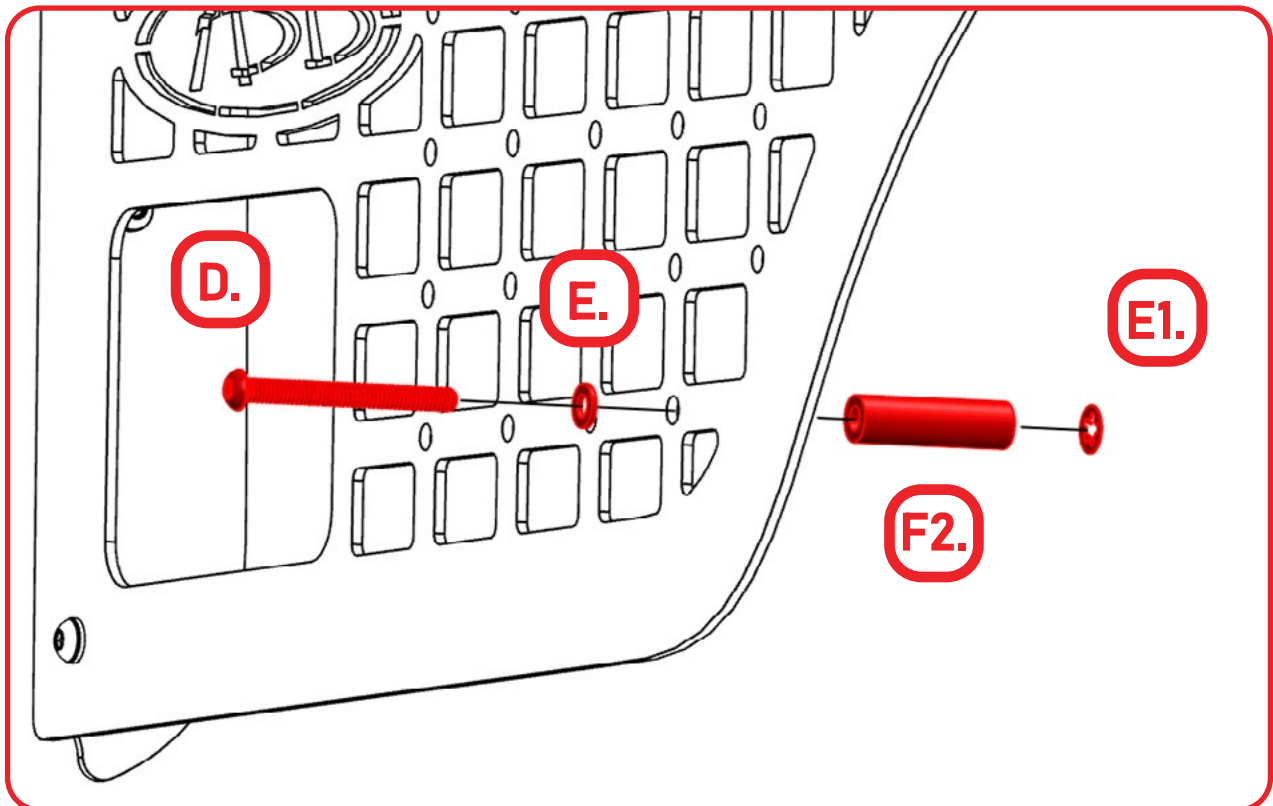



# INSTALLATION GUIDE

## BED SIDE MOLLE PASSENGER SIDE 2019-UP/RAM 2500

## INSTALL

### □ STEP 13

Re-Install the rear panel and install the provided (A, E) 1/4 hardware using a (5/32 allen).



### □ STEP 14

Assemble the front panel as shown below using the provided (A, E) 1/4 hardware using a (5/32 allen).

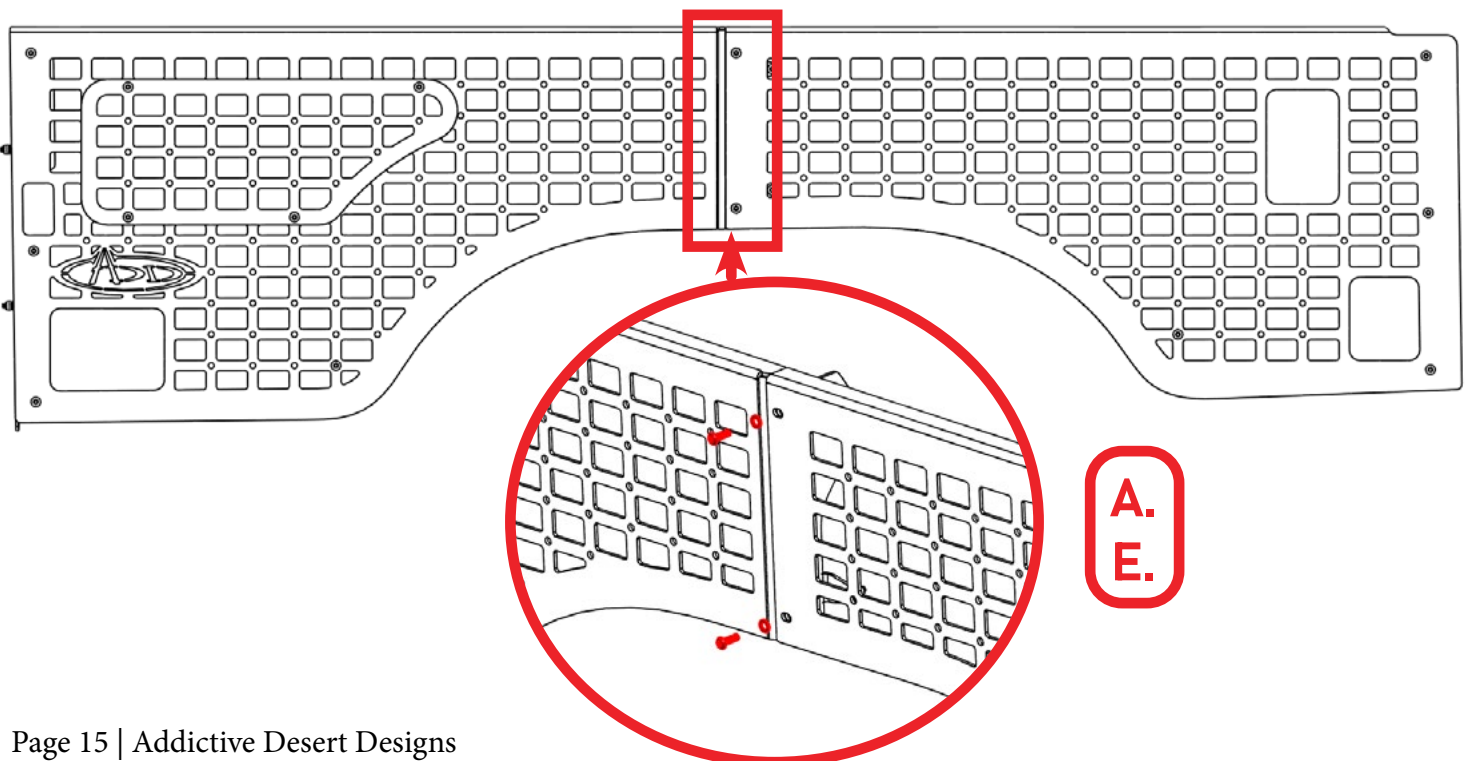

## BED SIDE MOLLE PASSENGER SIDE 2019-UP/RAM 2500

## INSTALL

### □ STEP 15

Hold the panel up with the top of the panel flush with the top of the bed. Next, mark out the 4x holes as shown below. Remove panel and set aside. Next, using a (25/64 drill bit) drill the marked hole and install the provided **(G)** 1/4 rivet nuts using a (rivet nut hand tool).

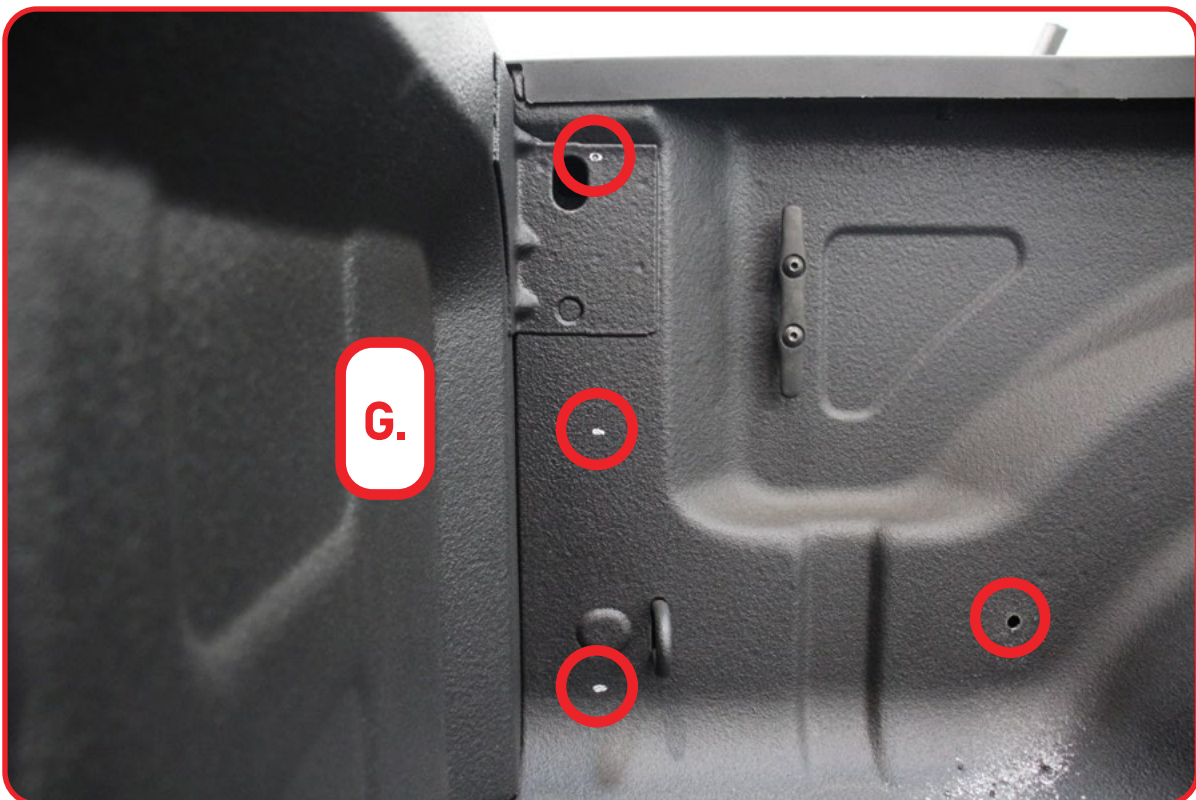



## BED SIDE MOLLE PASSENGER SIDE 2019-UP/RAM 2500

## INSTALL

### STEP 16

Install the provided (C, E, F1, E1) 1/4 bolt, washer, 3/4 spacer, and push nut in the order shown in figure 1 in the hole next to the wheel well. Install the provided (B, E, F, E1) 1/4 bolt, washer, 1/2 spacer, and push nut in the order shown in figure 2 in the holes next to the back of the bed.

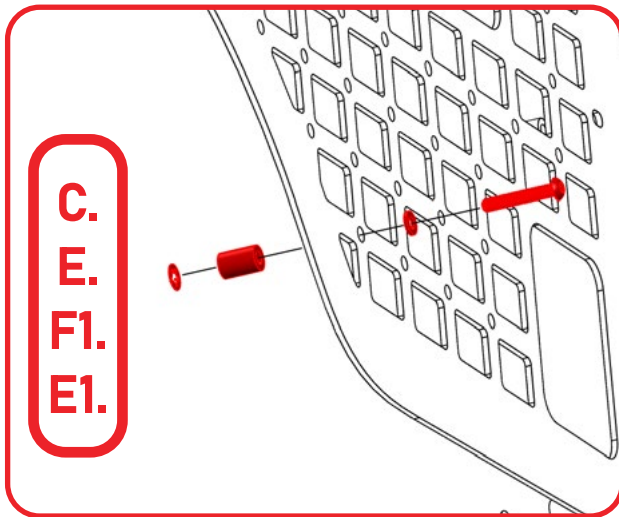
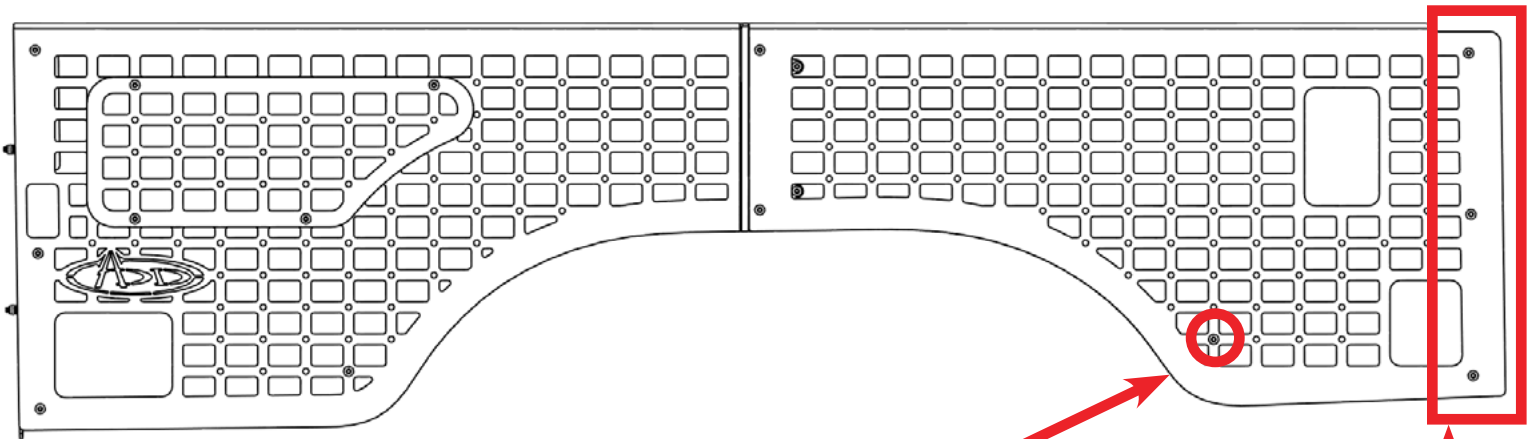

FIG. 1

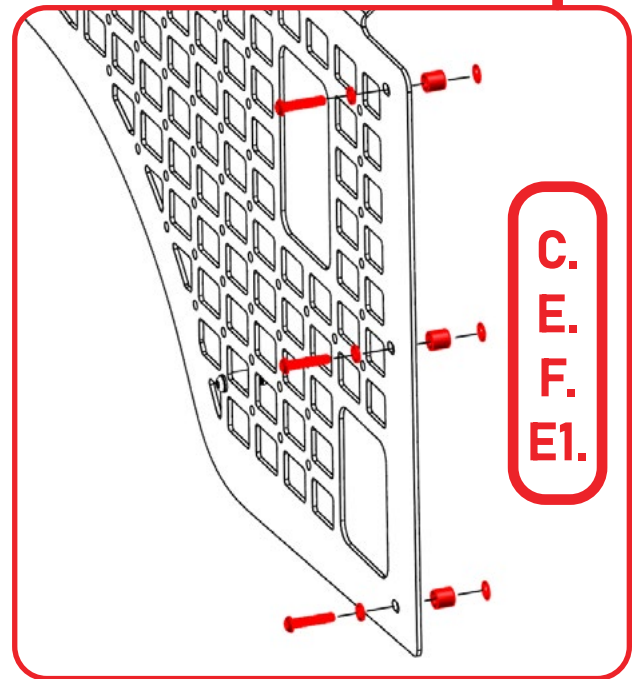

FIG. 2

## BED SIDE MOLLE PASSENGER SIDE 2019-UP/RAM 2500

## INSTALL

### □ STEP 17

Re-Install the front panel into the rivet nuts installed on **step 15**.

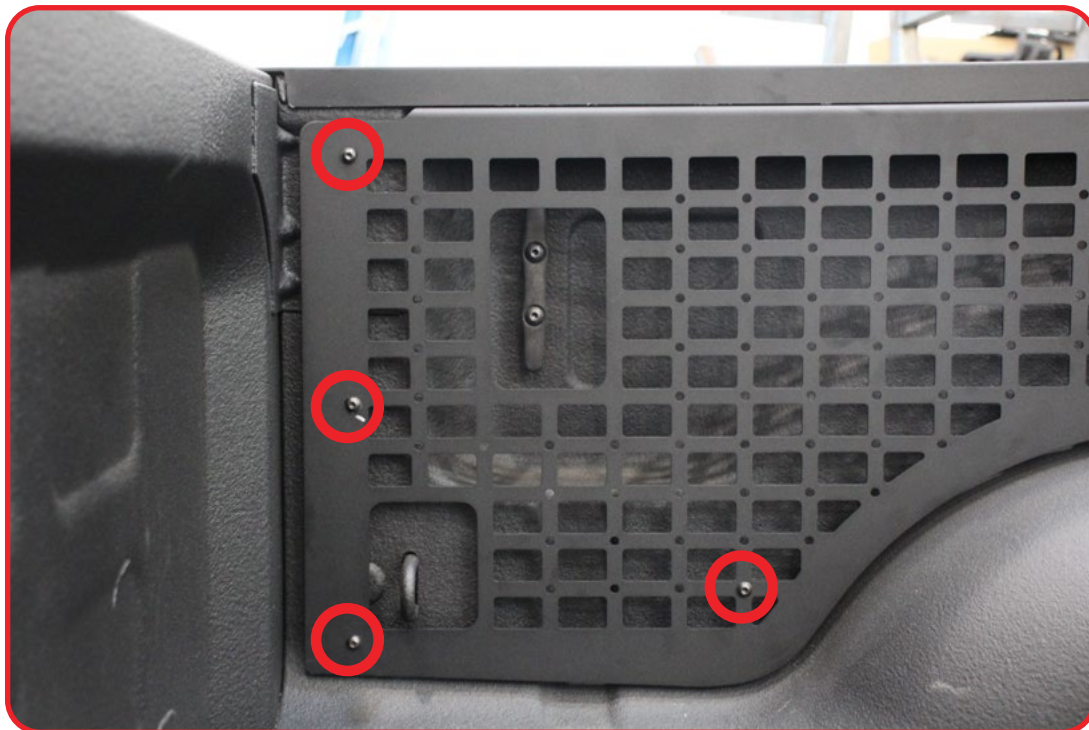



# INSTALLATION GUIDE

BED SIDE MOLLE PASSENGER SIDE  
2019-UP/RAM 2500

**FINAL**

**□ STEP 18**

Stand back and enjoy your new ADD Bed Side Molle.

Check and re-tighten all mounting bolts after 100 miles and periodically thereafter.



THIS PRODUCT IS PROTECTED BY ONE OR MORE U.S. PATENTS  
[WWW.ADDICTIVEDESERTDESIGNS.COM/PATENTS](http://WWW.ADDICTIVEDESERTDESIGNS.COM/PATENTS)

FOR ADDITIONAL SUPPORT OR TECHNICAL QUESTIONS,  
PLEASE CALL 480-671-0820 OR  
EMAIL [INFO@ADDICTIVEDESERTDESIGNS.COM](mailto:INFO@ADDICTIVEDESERTDESIGNS.COM)