



# INSTALLATION GUIDE

## 2024-UP/FORD RANGER RAPTOR

BED SIDE MOLLE PASSENGER SIDE

AC7203301NA

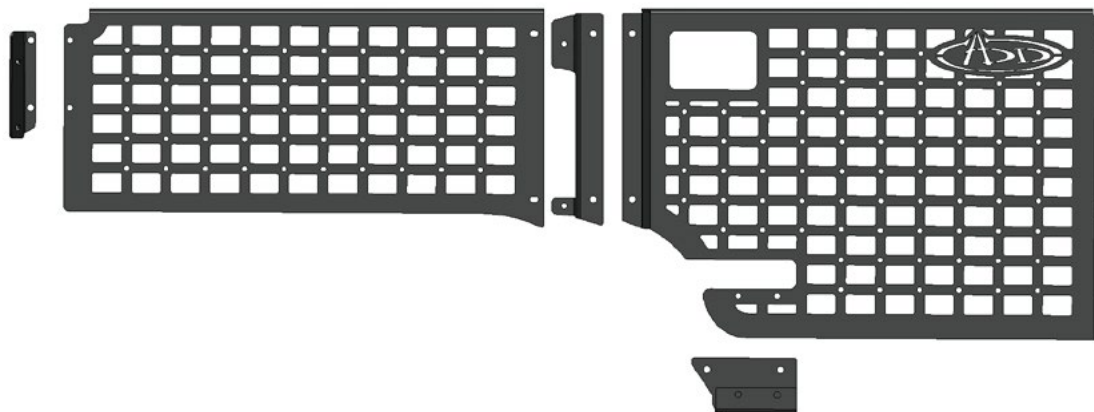

### TOOLS REQUIRED

- (Allen) 5/16, 5/32, 5MM
- (Torx) T40
- Step Up Drill Bit
- (Drill Bit) 25/64
- Ratchet
- Drill
- Marker
- Rivet Nut Hand Tool



### TIME REQUIRED

30 Minutes



### SKILL LEVEL

Level 2 | Easy

## ⚠️ WARNINGS/CAUTIONS BEFORE STARTING INSTALLATION ⚠️

-BEFORE YOU INSTALL THIS KIT-

**Read and understand all instructions,** warnings, cautions, & notes contained in this installation instruction guide. Consult your vehicle owner's manual for proper disconnection of electrical and lifting of vehicle if required for installation of this product.

This install may require some technical skills and knowledge of basic mechanical work. If you do not feel that you are capable of performing this install please take this product to a trained professional.

After reading this guide please contact us with any questions or concerns before installing product.

Customer Service (480) 671-0820

Addictive desert designs is not responsible for any bodily injury or harm to you or your vehicle as a result of an improper install.

Proper installation of this kit required knowledge of the factory recommended procedures for removal and installation of original equipment components.

We recommend that the factory shop manual and any special tools needed to service your vehicle be on hand during the installation. Installation of this kit without proper knowledge of the factory recommended procedures may affect the performance of these

components and the safety of the vehicle. Inspect all contents of this package to make sure product is not damaged and all installation hardware has been included. If parts are missing from kit, please be prepared to provide the following information:

1. Name of purchase location
2. Bar Code on side of box
3. Date above bar code
4. Date inside box cover

**\*ALWAYS WEAR EYE PROTECTION WHEN OPERATING POWER TOOLS\***



## HARDWARE/PARTS

**A.**



1/4-20 X 3/4" BUTTON HEAD BOLT

QTY: 9

**A1.**



M6 WASHER

QTY: 9

**A2.**



1/4-20" RIVET NUT

QTY: 3

**B.**



M8 WASHER

QTY: 2

**B1.**



M8-1.25 X 30MM BUTTON HEAD BOLT

QTY: 2

Reference this page throughout the install



# INSTALLATION GUIDE

## BED SIDE MOLLE PASSENGER SIDE 2024-UP/FORD RANGER RAPTOR

## INSTALL

### □ STEP 1

Remove the tie down brackets using a (T40 torx bit).

**TECH TIP:** Use a butane torch to heat up the head of the bolts due to thread lock for easy removal

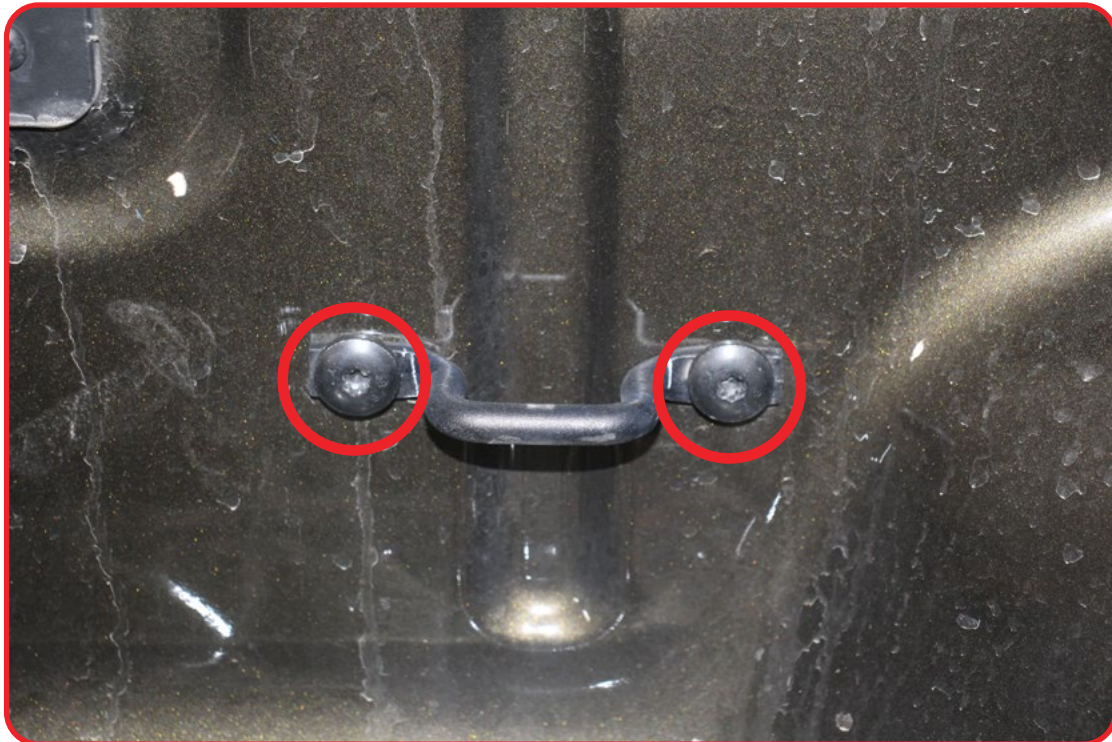
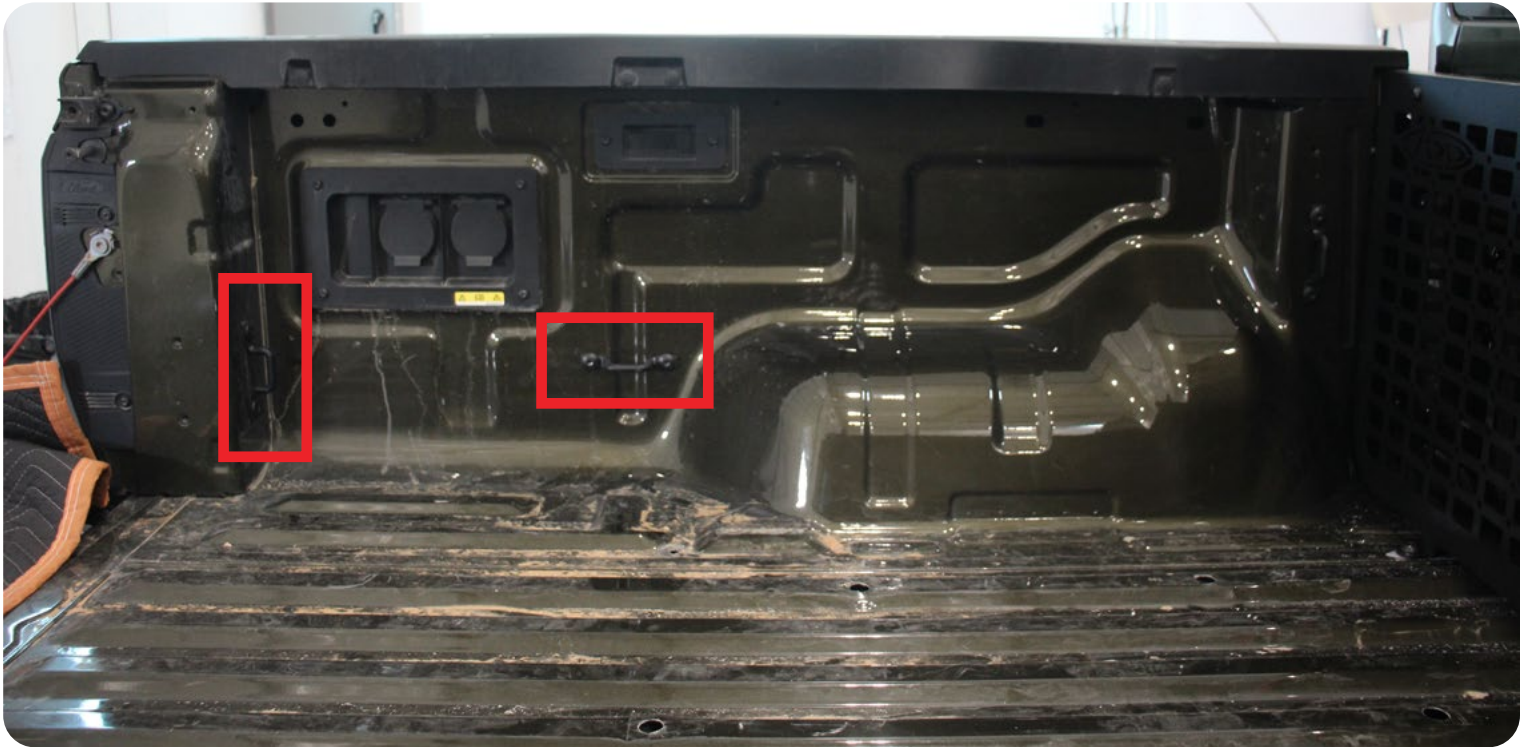



# INSTALLATION GUIDE

## BED SIDE MOLLE PASSENGER SIDE 2024-UP/FORD RANGER RAPTOR

## INSTALL

### STEP 2

Install the provided mounting brackets to the rear section of the bed side molle with the provided (A, A1) 1/4 hardware using a (5/32 allen).

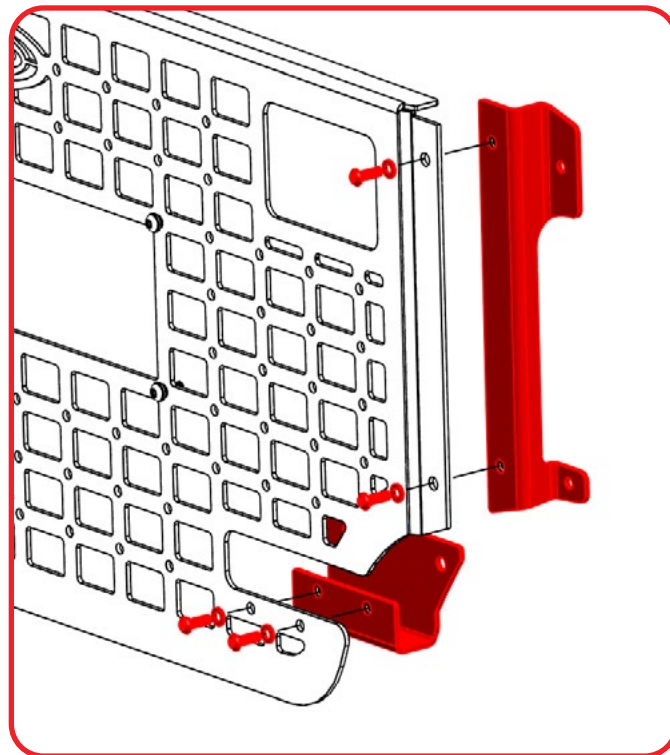
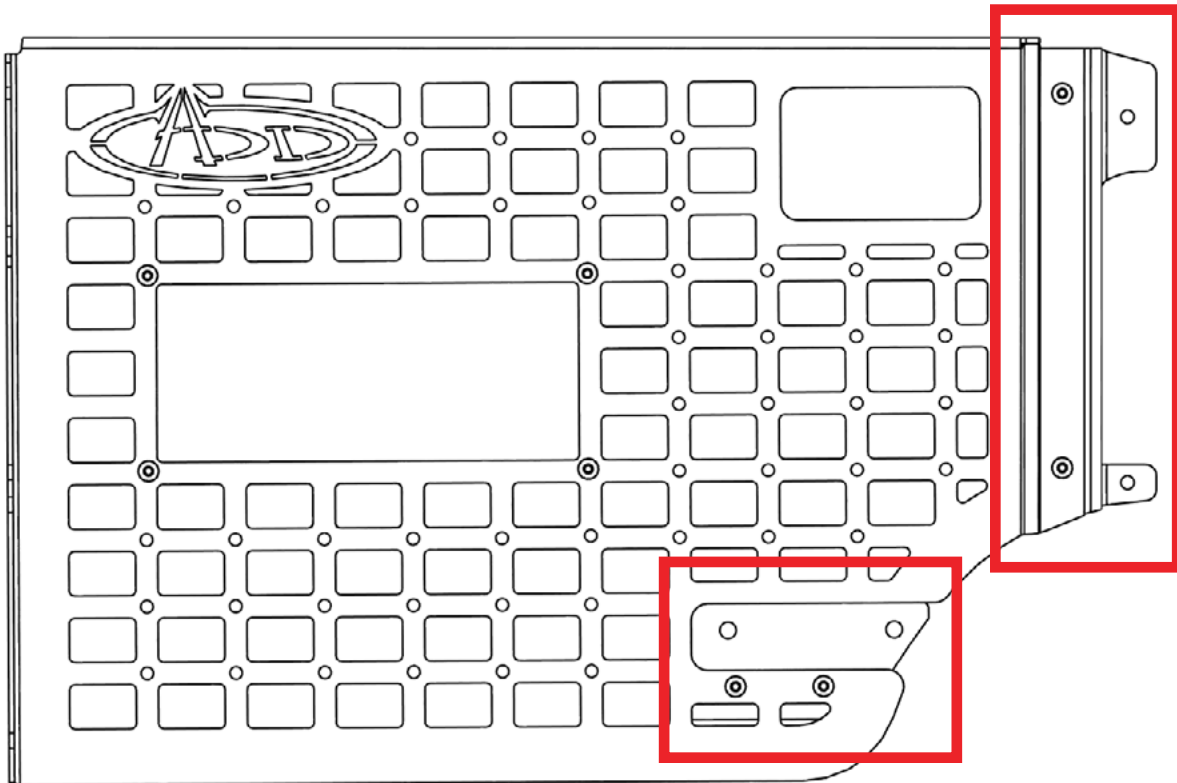

A.  
A1.



# INSTALLATION GUIDE

## BED SIDE MOLLE PASSENGER SIDE 2024-UP/FORD RANGER RAPTOR

## INSTALL

### □ STEP 3

Install the rear section of the bed side molle with the provided **(B, B1)** M8 hardware using a (5mm allen) and re-install the tie down bracket as shown below.

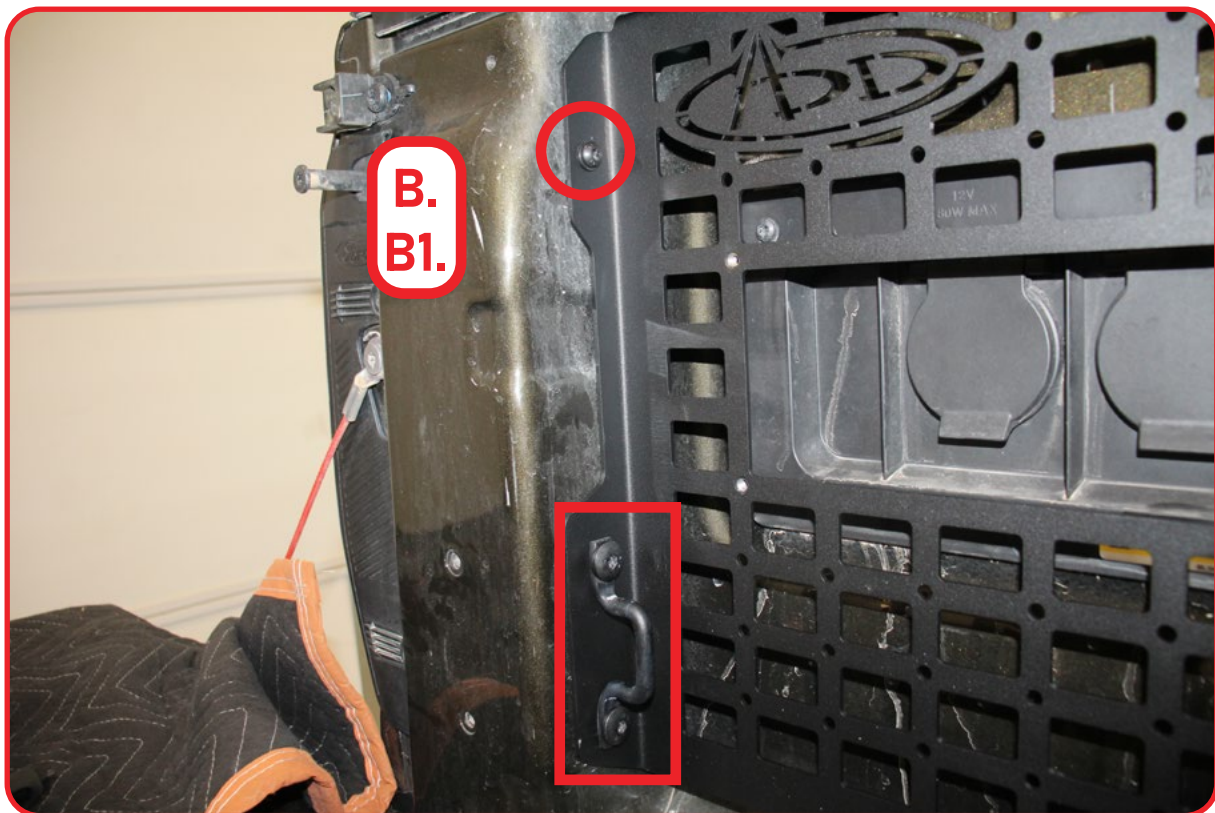



# INSTALLATION GUIDE

## BED SIDE MOLLE PASSENGER SIDE 2024-UP/FORD RANGER RAPTOR

## INSTALL

### □ STEP 4

Install the other tie down bracket as highlighted below.





# INSTALLATION GUIDE

## BED SIDE MOLLE PASSENGER SIDE 2024-UP/FORD RANGER RAPTOR

## INSTALL

### □ STEP 5

Mark the mounting holes located in the middle. Then, remove the molle panel and set aside.

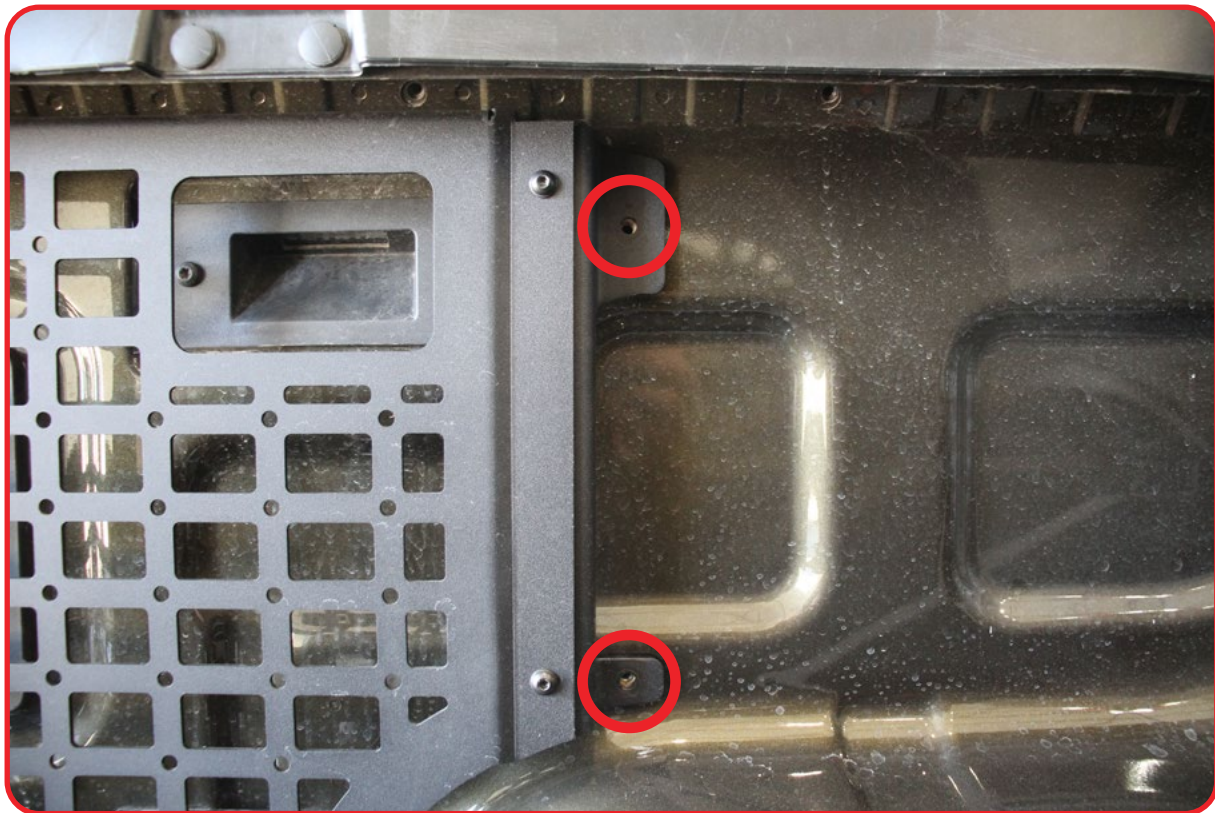



# INSTALLATION GUIDE

## BED SIDE MOLLE PASSENGER SIDE 2024-UP/FORD RANGER RAPTOR

## INSTALL

### □ STEP 6

Using a (25/64 drill bit) Drill the mounting holes marked on **step 5**. Next, install the provided **(A2)** 1/4 rivet nut using a (rivet nut hand tool).







# INSTALLATION GUIDE

## BED SIDE MOLLE PASSENGER SIDE 2024-UP/FORD RANGER RAPTOR

## INSTALL

### □ STEP 7

Re-Install the rear panel and install the provided (A, A1) 1/4 hardware using a (5/32 allen) into the rivet nuts from step 6.

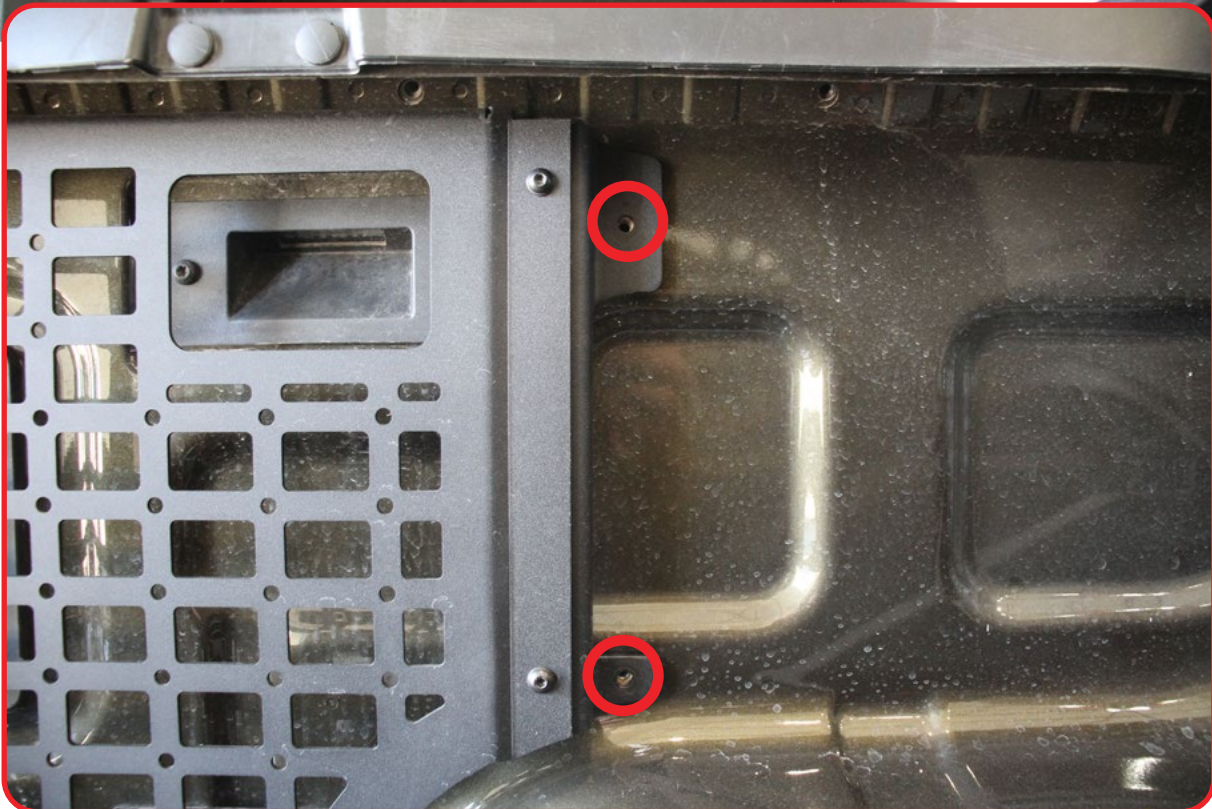



# INSTALLATION GUIDE

## BED SIDE MOLLE PASSENGER SIDE 2024-UP/FORD RANGER RAPTOR

## INSTALL

### STEP 8

Assemble the front panel as shown below using the provided (A, A1) 1/4 hardware using a (5/32 allen).

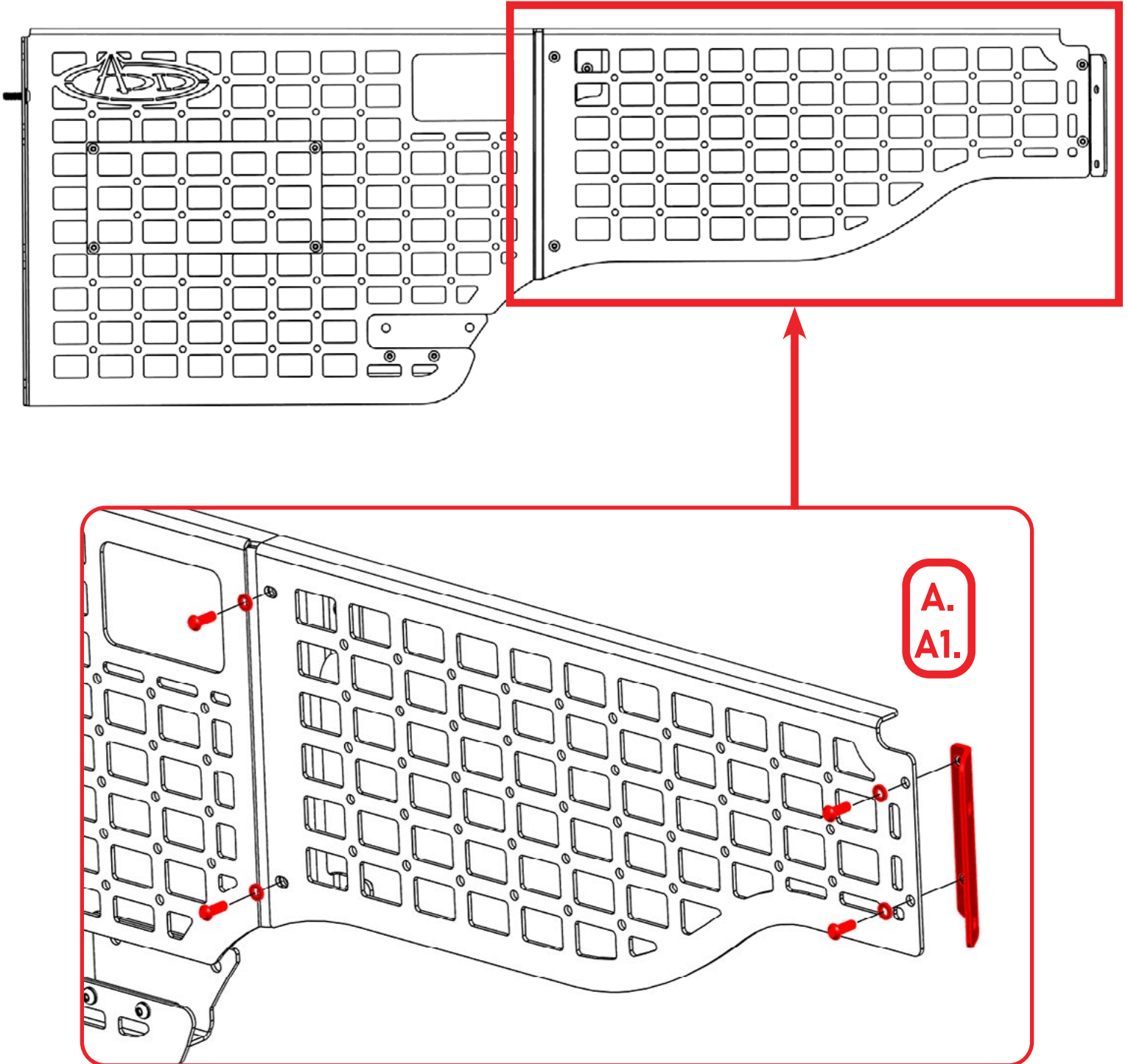



# INSTALLATION GUIDE

## BED SIDE MOLLE PASSENGER SIDE 2024-UP/FORD RANGER RAPTOR

## INSTALL

### □ STEP 9

Install the provided **(B, B1)** M8 hardware into the top mounting hole using a (5mm allen) and mark the bottom hole.

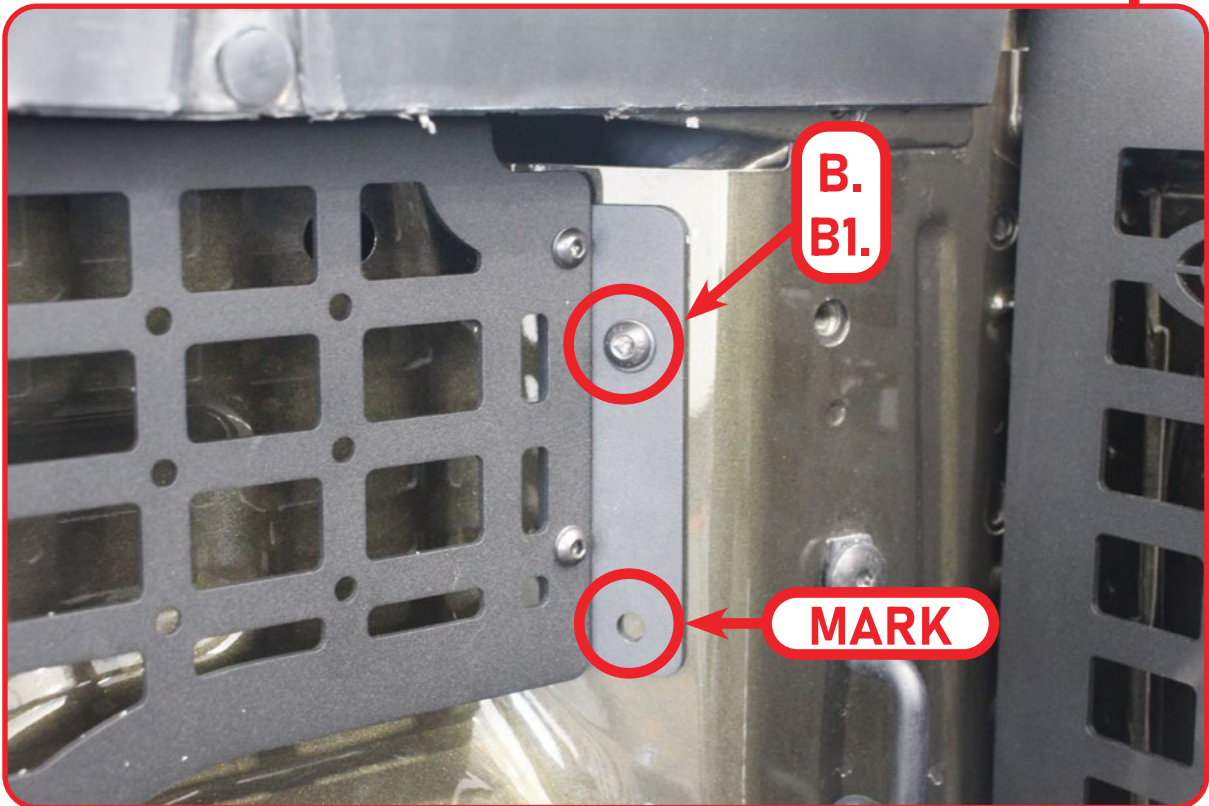

## BED SIDE MOLLE PASSENGER SIDE 2024-UP/FORD RANGER RAPTOR

## INSTALL

### □ STEP 10

Remove the front panel and drill the marked hole using a (25/64 drill bit). Next using a (rivet nut hand tool) install the provided (A2) 1/4 rivet nut into the drilled hole.

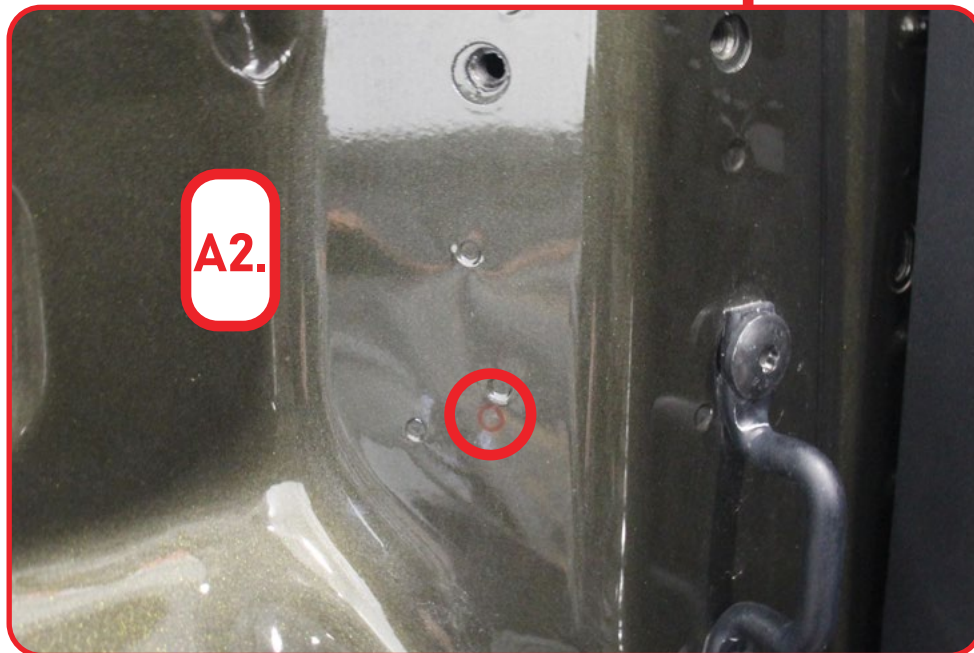
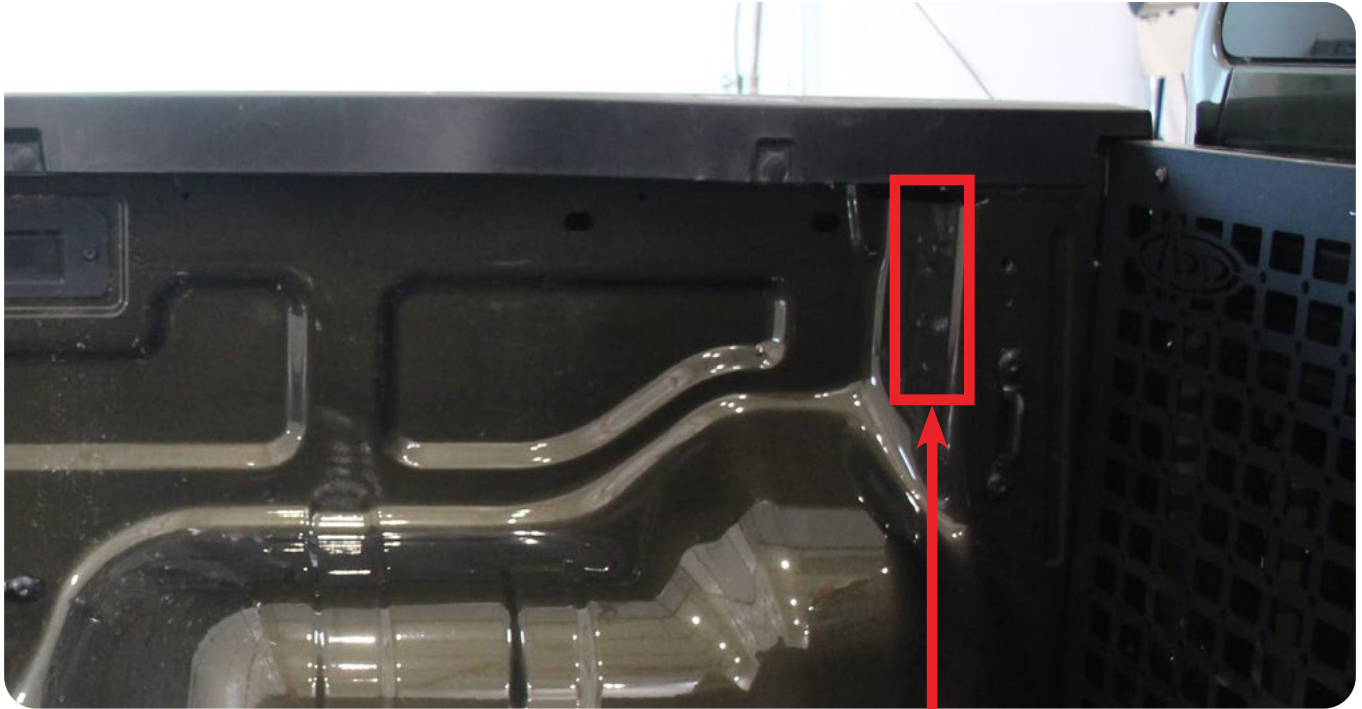



# INSTALLATION GUIDE

## BED SIDE MOLLE PASSENGER SIDE 2024-UP/FORD RANGER RAPTOR

## INSTALL

### □ STEP 11

Re-Install the front panel and install the provided **(B, B1)** M8 hardware using a (5mm allen) and install the provided **(A, A1)** 1/4 hardware using a (5/32 allen).

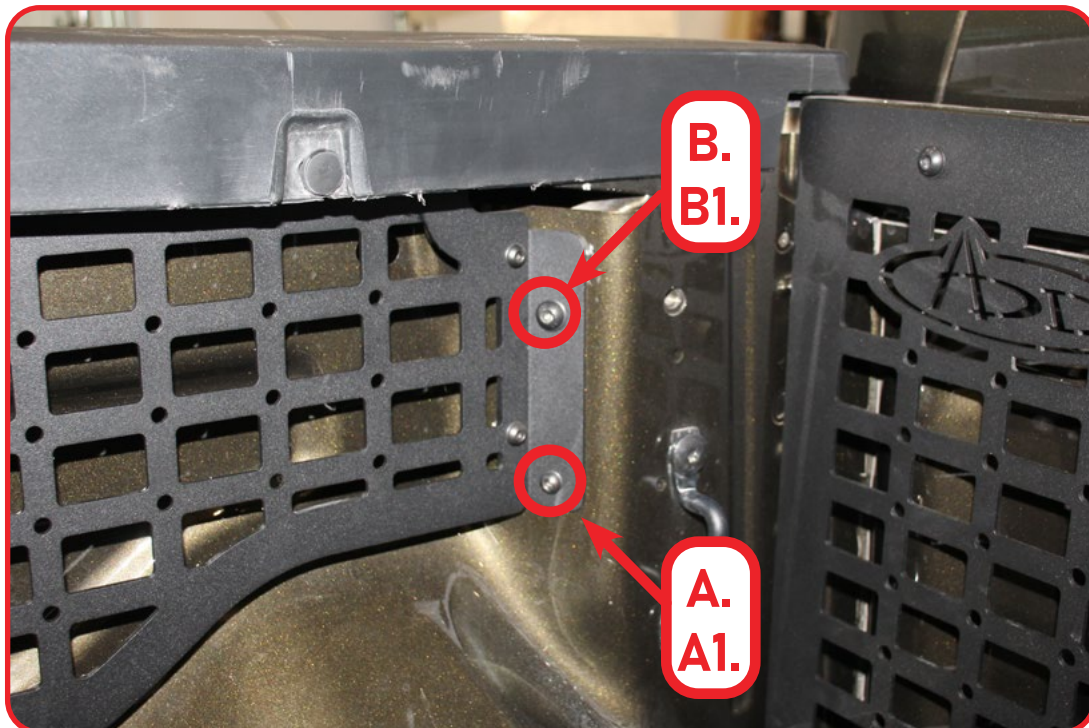
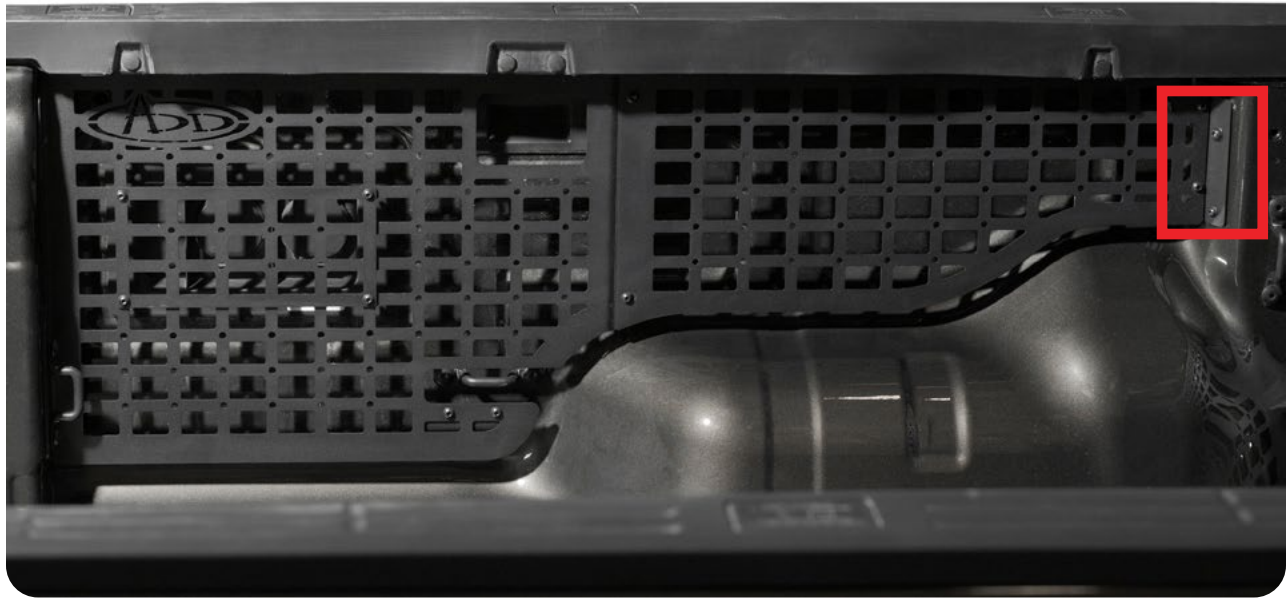



# INSTALLATION GUIDE

## BED SIDE MOLLE PASSENGER SIDE 2024-UP/FORD RANGER RAPTOR

## FINAL

### STEP 12

Stand back and enjoy your new ADD Bed Side Molle.

Check and re-tighten all mounting bolts after 100 miles and periodically thereafter.

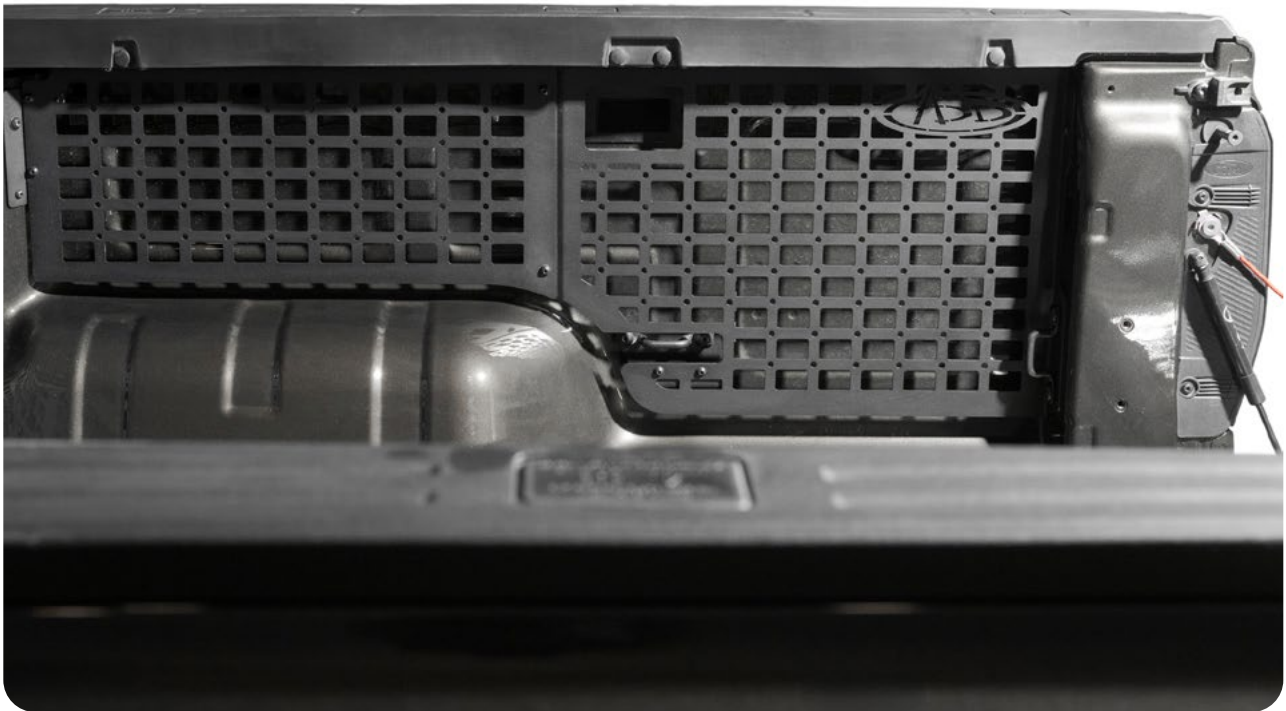

THIS PRODUCT IS PROTECTED BY ONE OR MORE U.S. PATENTS  
[WWW.ADDICTIVEDESERTDESIGNS.COM/PATENTS](http://WWW.ADDICTIVEDESERTDESIGNS.COM/PATENTS)

FOR ADDITIONAL SUPPORT OR TECHNICAL QUESTIONS,  
PLEASE CALL 480-671-0820 OR  
EMAIL [INFO@ADDICTIVEDESERTDESIGNS.COM](mailto:INFO@ADDICTIVEDESERTDESIGNS.COM)