

2024/TOYOTA TACOMA

STEALTH REAR BUMPER

R670081280103



TOOLS REQUIRED

(Allen) 5/32, 7/32
(Wrench) 10mm, 12mm, 7/16, 9/16, 3/4
(Socket) 10mm, 12mm, 7/16, 9/16, 3/4
Ratchet
Flat Head/Fastener Remover
Needle Nose Pliers
Grinder
Razor
Black Spray Paint

TIME REQUIRED

- 3 hours for OEM Removal/Bumper Install
-1 Additional Hour to Wire Lights

Labor Rates are based on a vehicle with no pre-existing damage. Wiring labor is based on a standard wiring procedure with light switches installed in an easily accessible location. Custom light triggering or switch mounting location will result in a greater labor charge.

SKILL LEVEL

-Easy/Intermediate

This installation requires 2 people for best results

WARNINGS/CAUTIONS BEFORE STARTING INSTALLATION

-BEFORE YOU INSTALL THIS KIT-

Read and understand all instructions, warnings, cautions, & notes contained in this installation instruction guide. Consult your vehicle owner's manual for proper disconnection of electrical and lifting of vehicle if required for installation of this product.

This install may require some technical skills and knowledge of basic mechanical work. If you do not feel that you are capable of performing this install please take this product to a trained professional.

After reading this guide please contact us with any questions or concerns before installing product.
Customer Service (480) 671-0820

Addictive desert designs is *not* responsible for any bodily injury or harm to you or your vehicle as a result of an improper install.

Proper installation of this kit required knowledge of the factory recommended procedures for removal and installation of original equipment components.

We recommend that the factory shop manual and any special tools needed to service your vehicle be on hand during the installation. Installation of this kit without proper knowledge of the factory recommended procedures may affect the performance of these components and the safety of the vehicle.

Inspect all contents of this package to make sure product is not damaged and all installation hardware has been included. If parts are missing from kit, please be prepared to provide the following information:

1. Name of purchase location
2. Bar Code on side of box
3. Date above bar code
4. Date inside box cover

***ALWAYS WEAR EYE PROTECTION
WHEN OPERATING POWER TOOLS***

HARDWARE/PARTS

A.



1/4-20 X 3/4" BUTTON HEAD
QTY: 2

A1.



1/4-20 X 1 1/4" BUTTON HEAD BOLT
QTY: 6

A2.



1/4-20" NYLON LOCK NUT
QTY: 8

A3.



1/4" FLAT WASHER
QTY: 8

B.

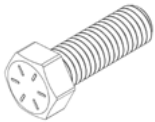

3/8-16 X 1" HEX HEAD BOLT BLACK
QTY: 6

B1.



3/8-16 X 1" BUTTON HEAD
QTY: 2

B2.



3/8-16 X 1 1/4" BUTTON HEAD BOLT
QTY: 8

B3.



3/8-16" U-NUT
QTY: 8

B4.



3/8-16" NYLON LOCK NUT
QTY: 8

B5.



3/8" FLAT WASHER
QTY: 14

C.

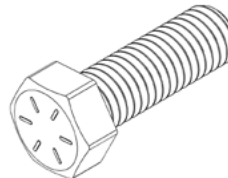

1/2-13 X 4" HEX HEAD BOLT GRADE 8
QTY: 4

C1.

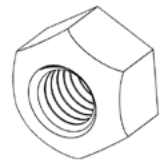

1/2-13" METAL LOCK NUT
QTY: 4

C2.



1/2" FLAT WASHER
QTY: 8

D.



SNAP IN NUT
QTY: 2

D1.



FLANGED HEX HEAD SCREW
QTY: 2

HARDWARE/PARTS

E.



1/4" SPACER

QTY: 6

F.



3M DOUBLE SIDED TAPE

QTY: 8

SENSOR GROMMETS SUPPLIED FOR NON SENSOR TRIMS



3/4" RUBBER SENSOR GROMMET
QTY: 4



3/4" PLASTIC SENSOR GROMMET PLUG
QTY: 4

STEALTH REAR BUMPER 2024/TOYOTA TACOMA

REMOVAL

□ STEP 1

Disconnect the main wiring harness located on the driver side.

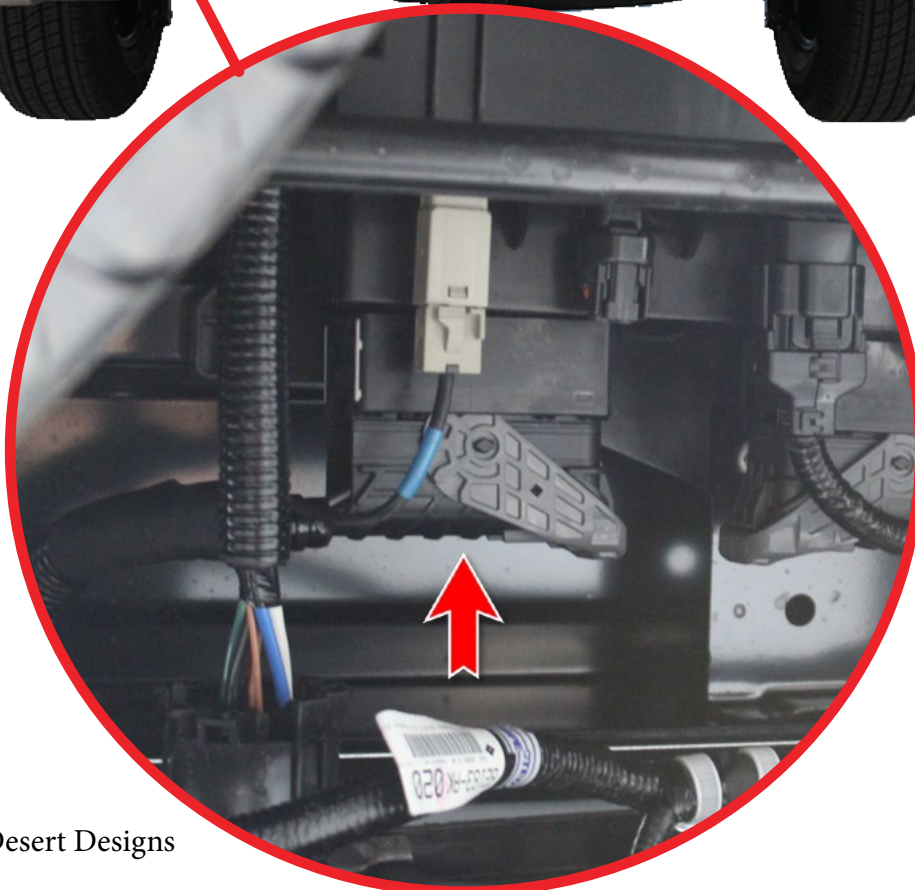

STEALTH REAR BUMPER 2024/TOYOTA TACOMA

REMOVAL

□ STEP 2

Unplug the trailer plug.



STEALTH REAR BUMPER 2024/TOYOTA TACOMA

REMOVAL

□ STEP 3

Using a (12mm socket), remove the side support brackets located on the side of the frame rails.

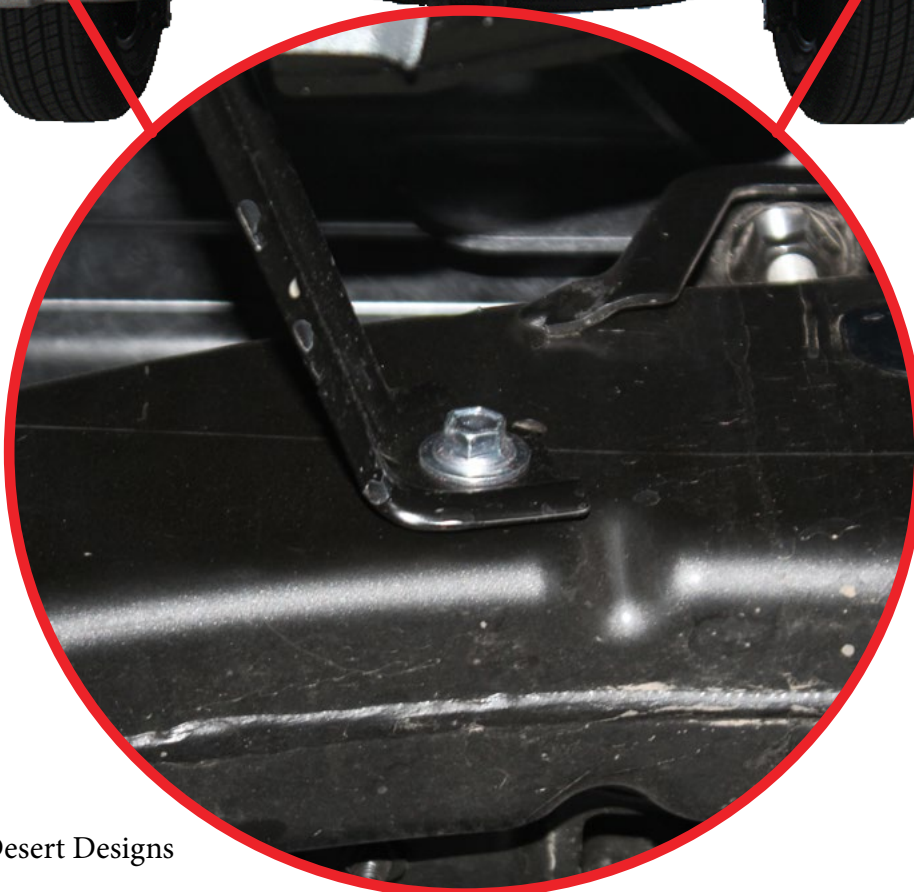

STEALTH REAR BUMPER 2024/TOYOTA TACOMA

REMOVAL

□ STEP 4

Using a (flathead screwdriver), remove the plastic covers located on top of the OEM bumper.



STEALTH REAR BUMPER 2024/TOYOTA TACOMA

REMOVAL

□ STEP 5

Using a (12mm socket), Remove the mounting bolts located underneath the plastic covers removed from step 4.



STEALTH REAR BUMPER 2024/TOYOTA TACOMA

REMOVAL

□ STEP 6

Using a (10mm socket), remove the mounting nuts located in the center. With another person, you can now remove the OEM bumper.



STEALTH REAR BUMPER 2024/TOYOTA TACOMA

REMOVAL

□ STEP 7

Using a (flathead screwdriver), Remove the push pins located on the underneath of the bumper as shown below.

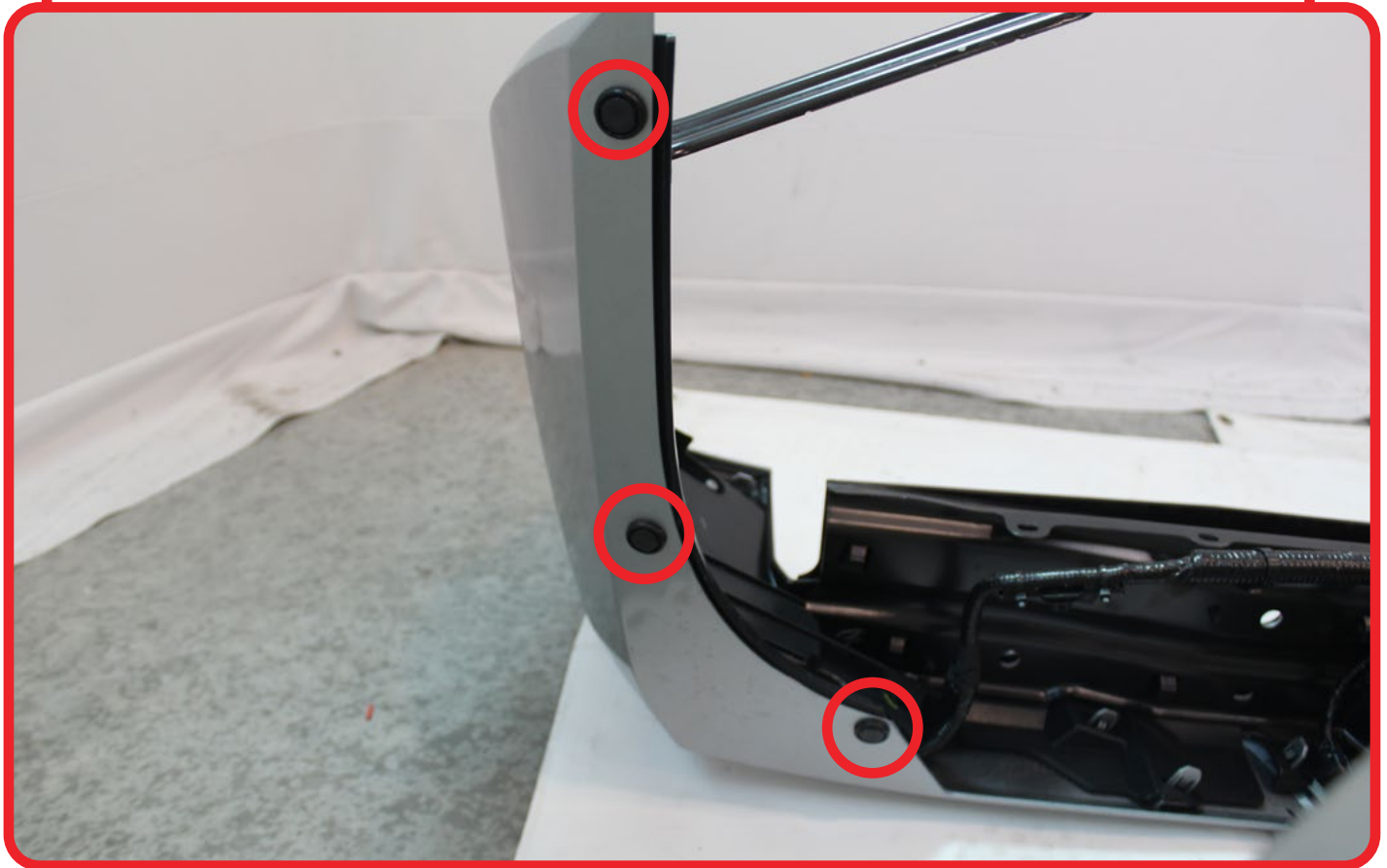
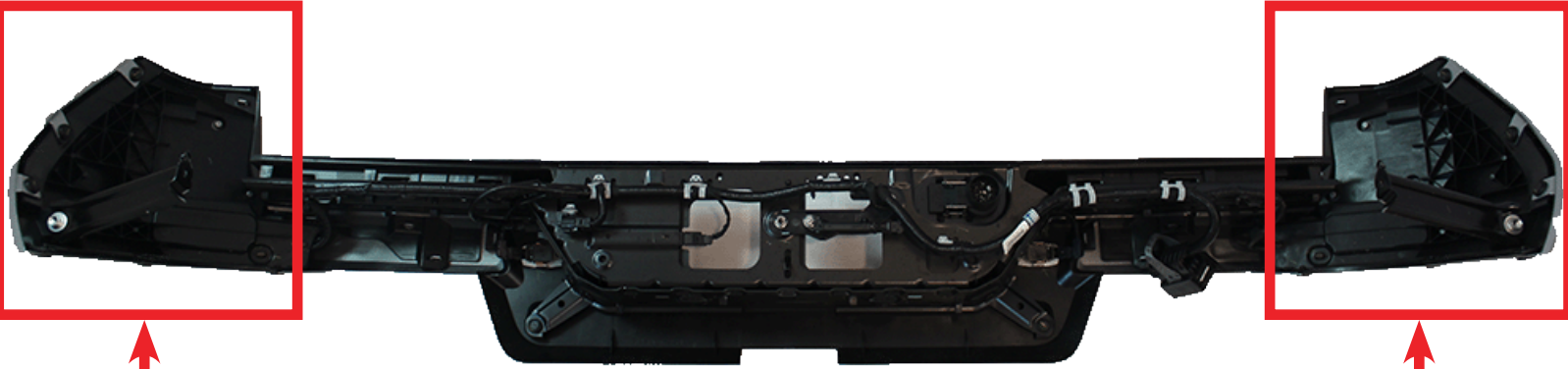

STEALTH REAR BUMPER 2024/TOYOTA TACOMA

REMOVAL

□ STEP 8

Remove the 4x sensors from the bezels by prying the tabs and pulling. ****Pry gently due to breakage****

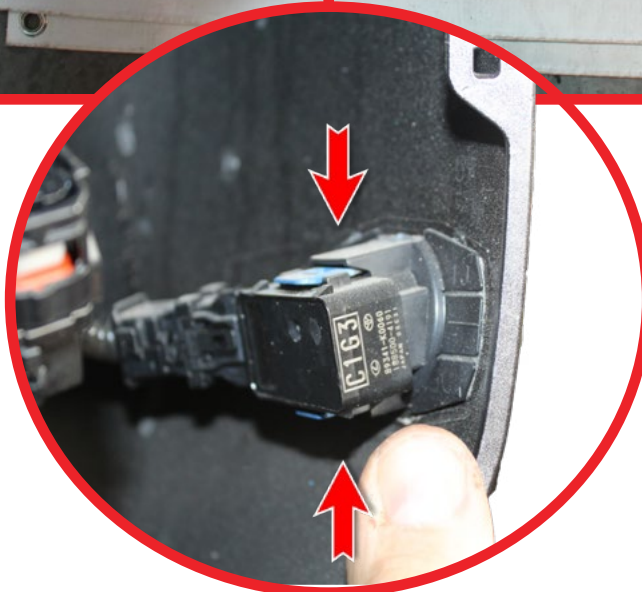
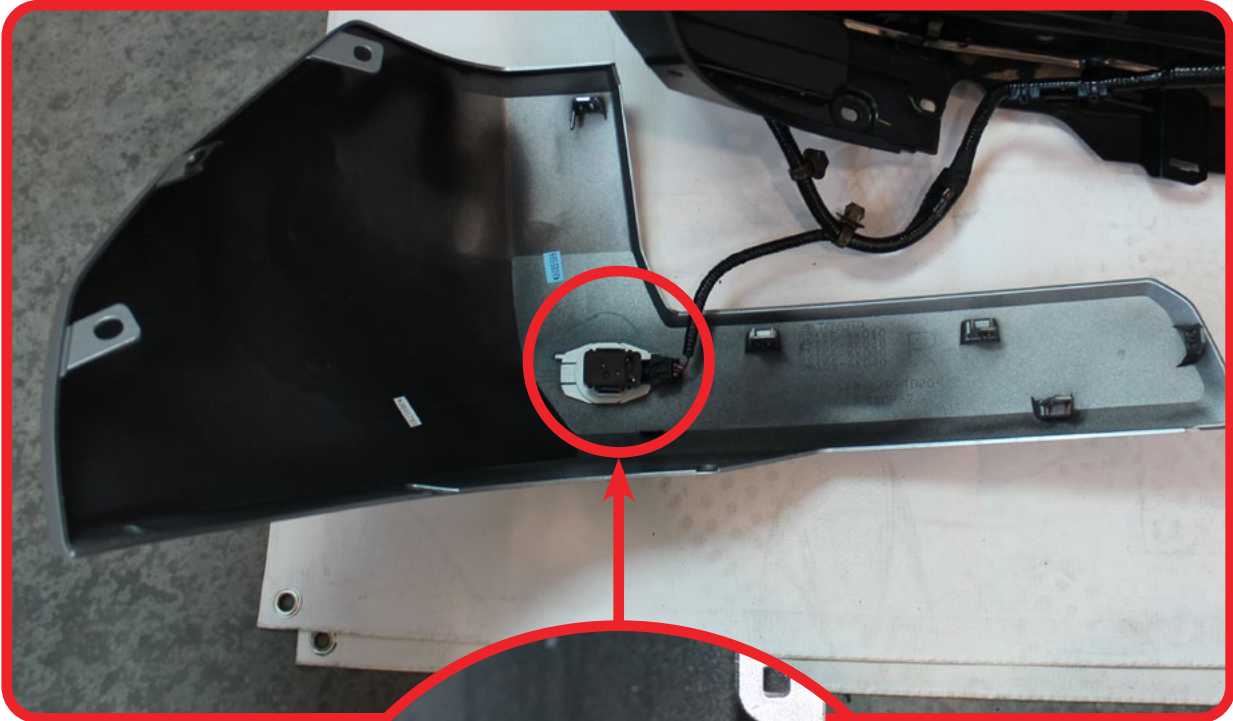
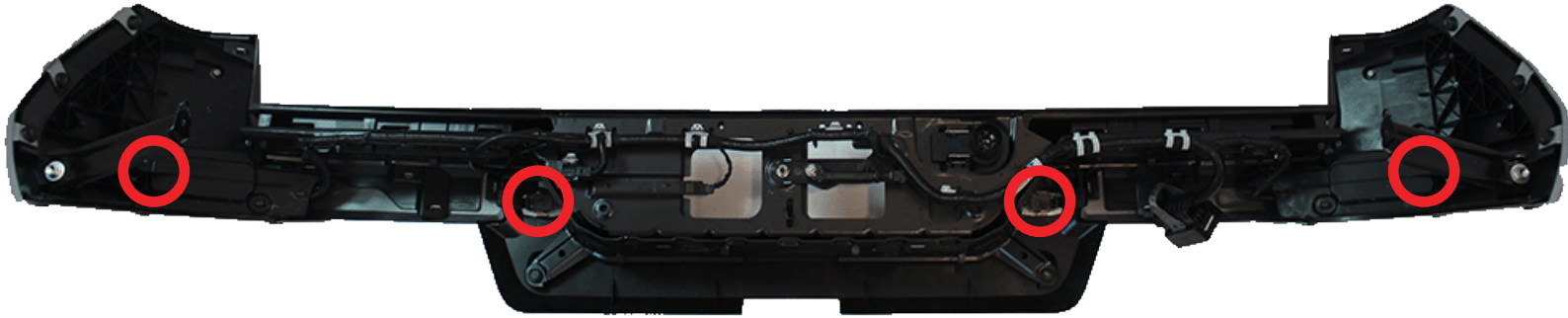

STEALTH REAR BUMPER 2024/TOYOTA TACOMA

REMOVAL

□ STEP 9

Using a (flathead screwdriver), remove the sensors bezels.

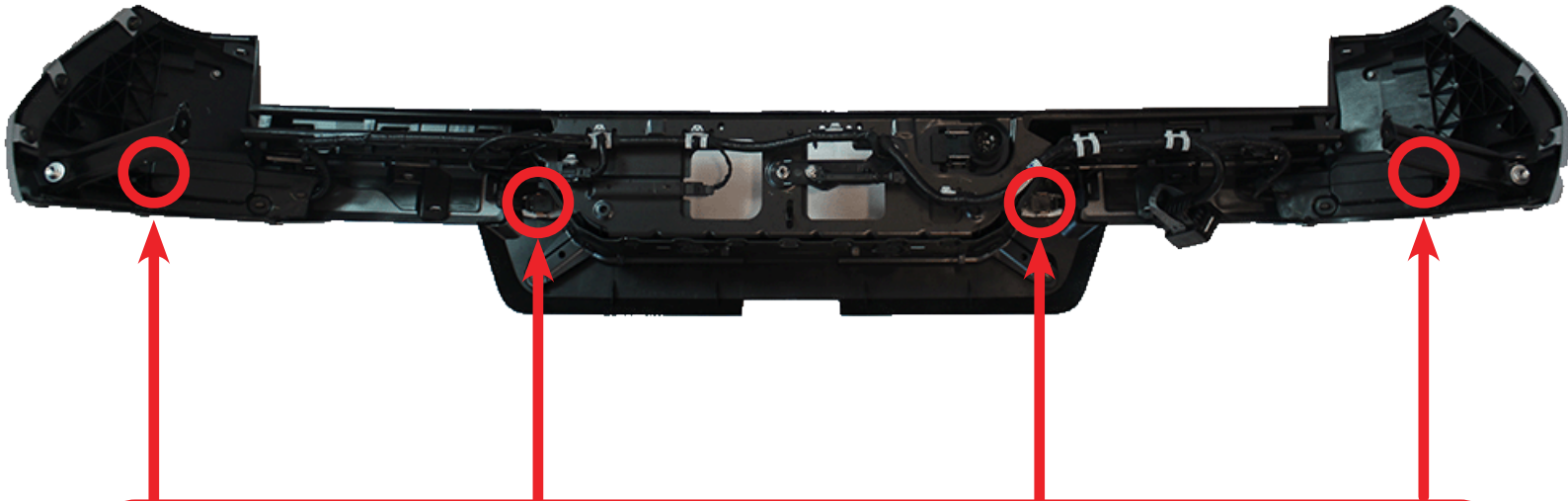

STEALTH REAR BUMPER 2024/TOYOTA TACOMA

REMOVAL

□ STEP 10

Remove all wiring loom clips with (needle nose pliers) from the OEM bumper.

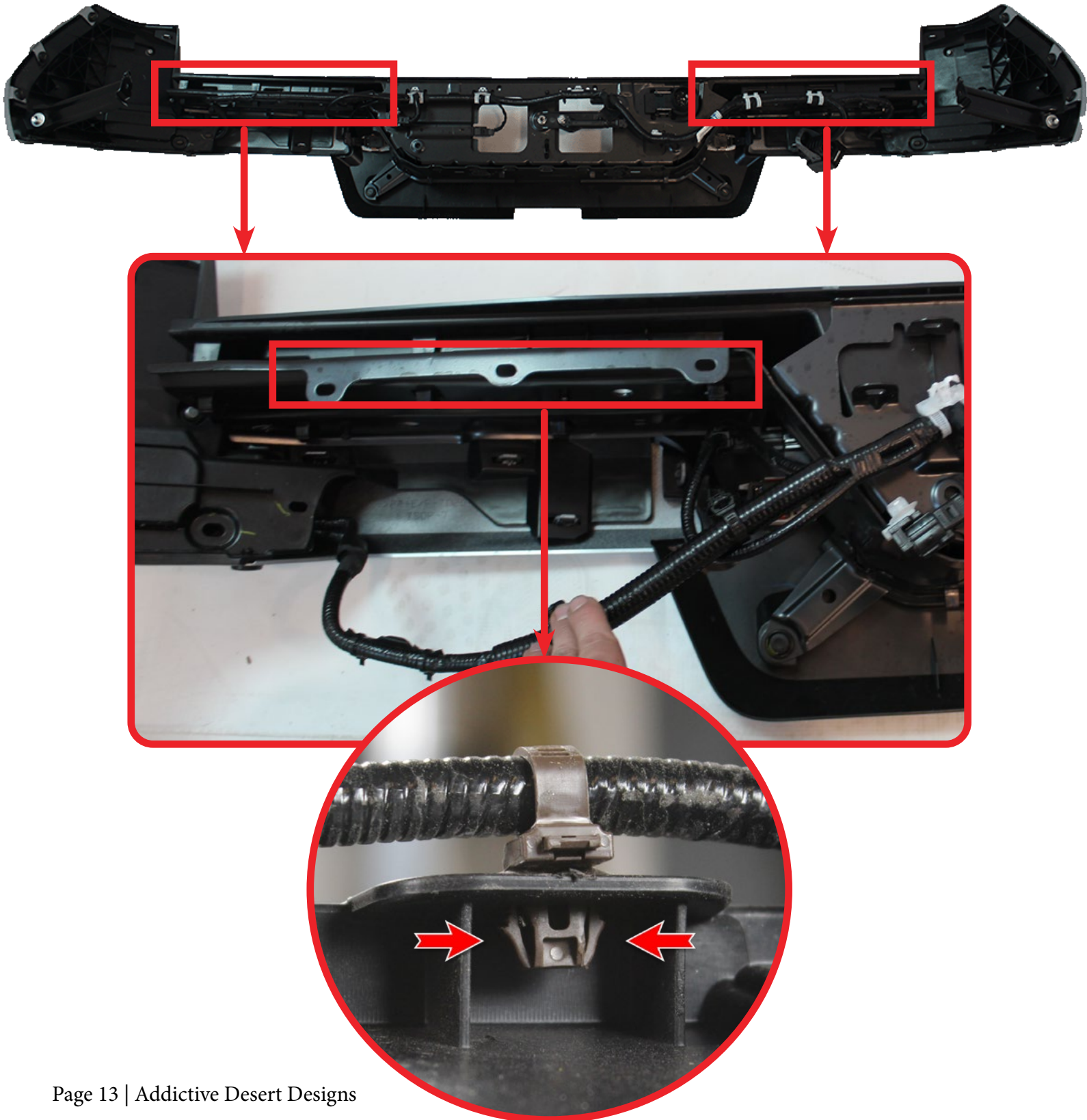

STEALTH REAR BUMPER 2024/TOYOTA TACOMA

REMOVAL

□ STEP 11

Using a (10mm socket) remove module 1. Next zip tie module 1 to the wire harness.

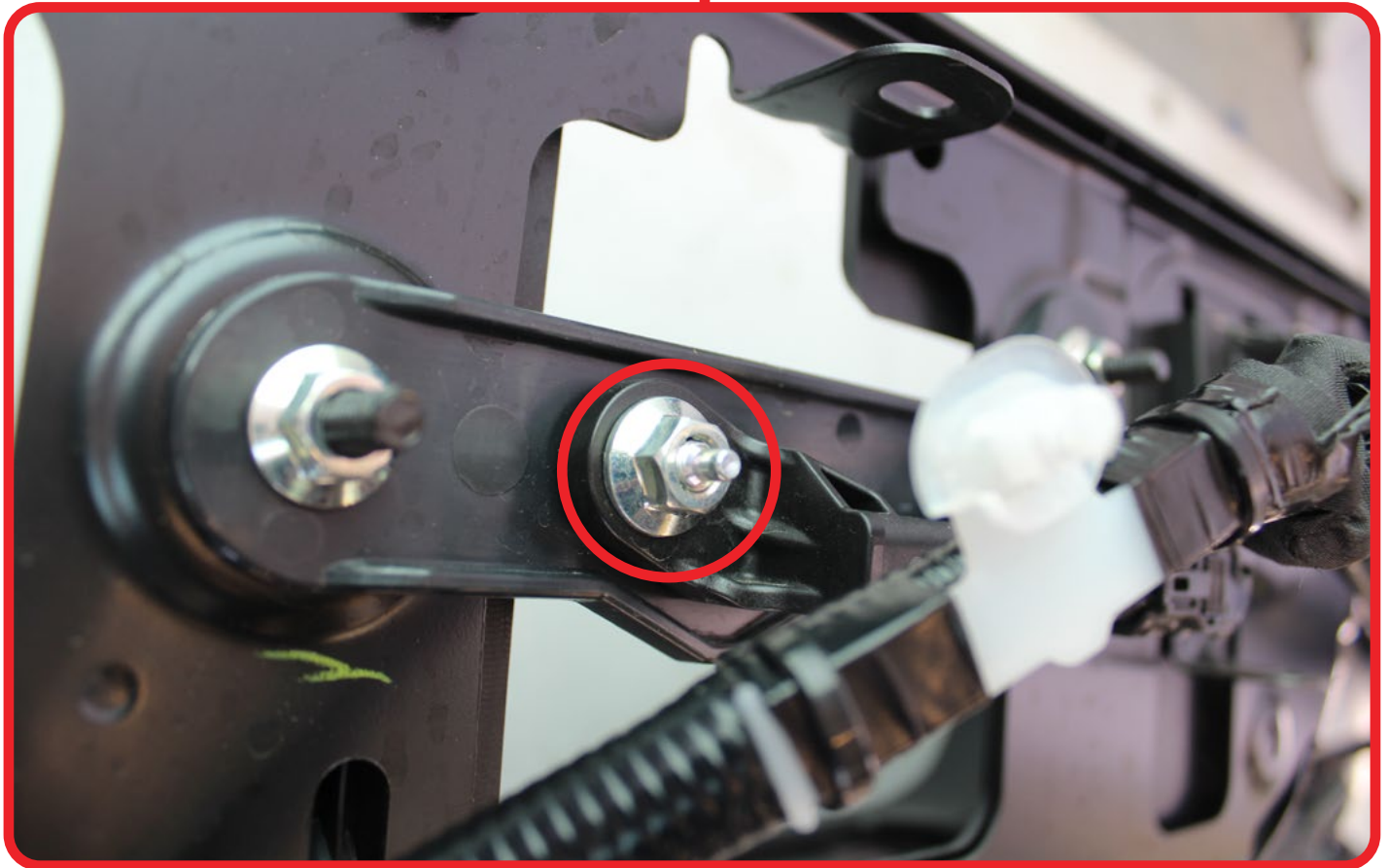
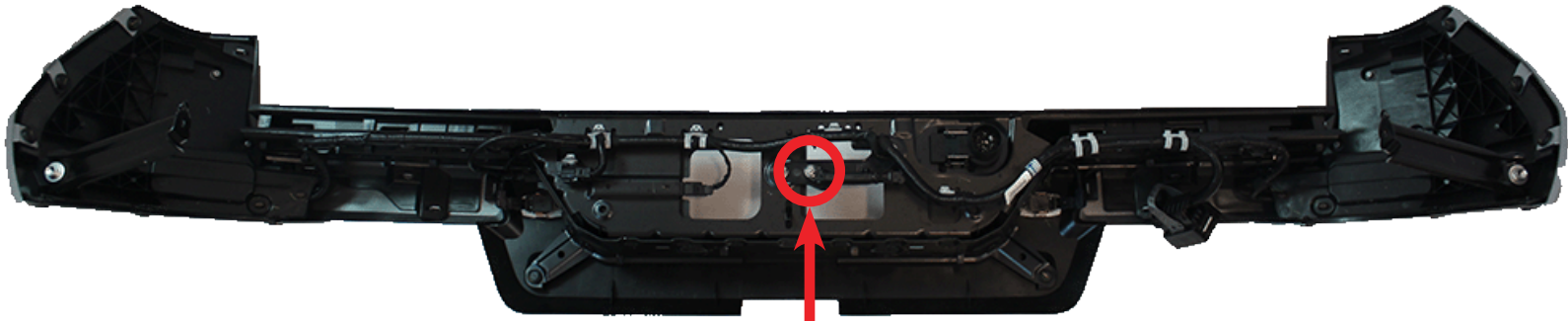

STEALTH REAR BUMPER 2024/TOYOTA TACOMA

REMOVAL

□ STEP 12

Using a (flathead screwdriver), pry the plastic away from the metal section and pull module 2 out. Zip tie module 2 to the wire harness.

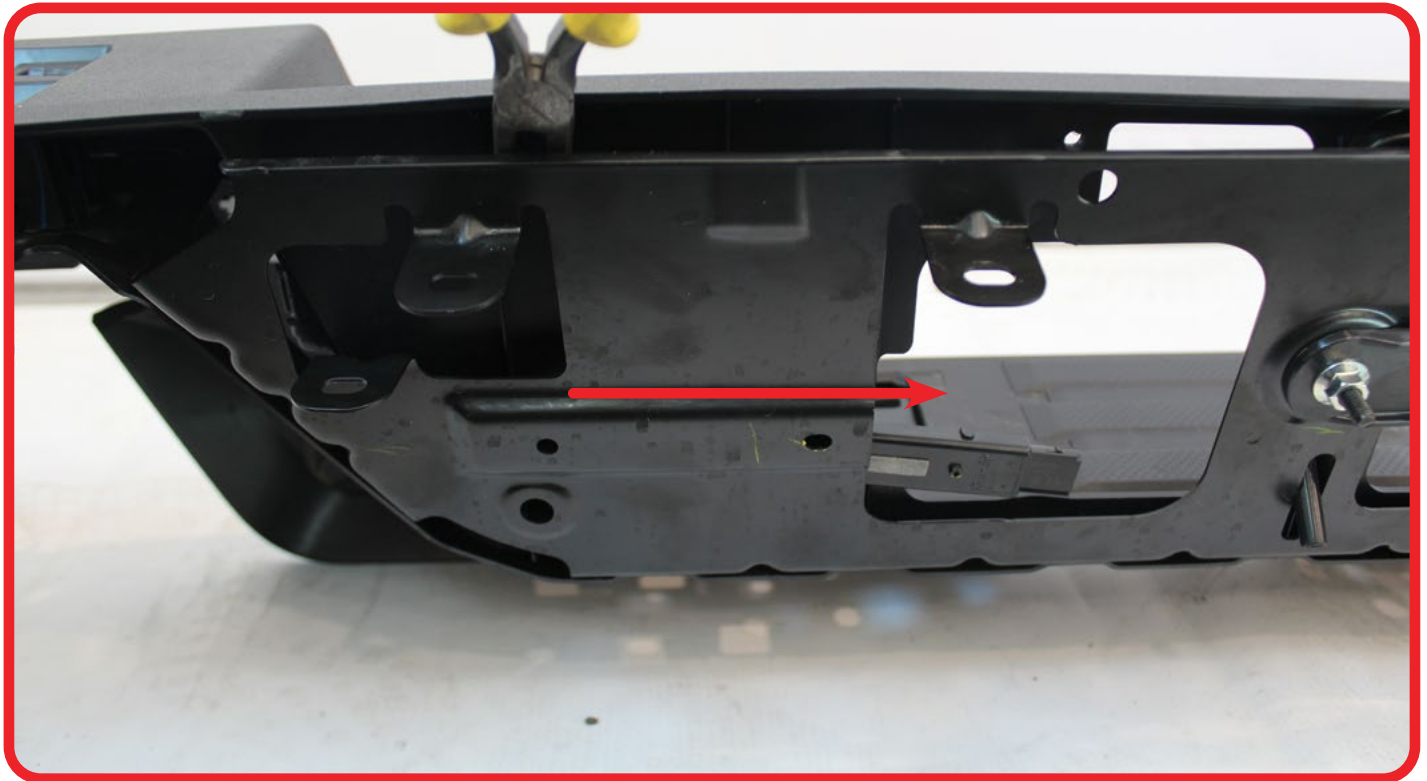
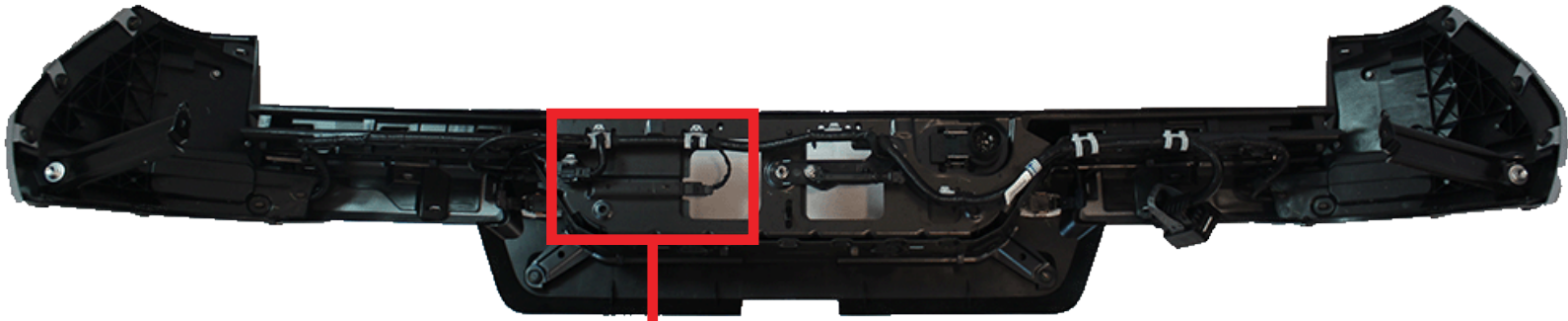

STEALTH REAR BUMPER 2024/TOYOTA TACOMA

REMOVAL

□ STEP 13

Remove the trailer plug on the backside of the bumper using a (flathead screwdriver) to release clips.

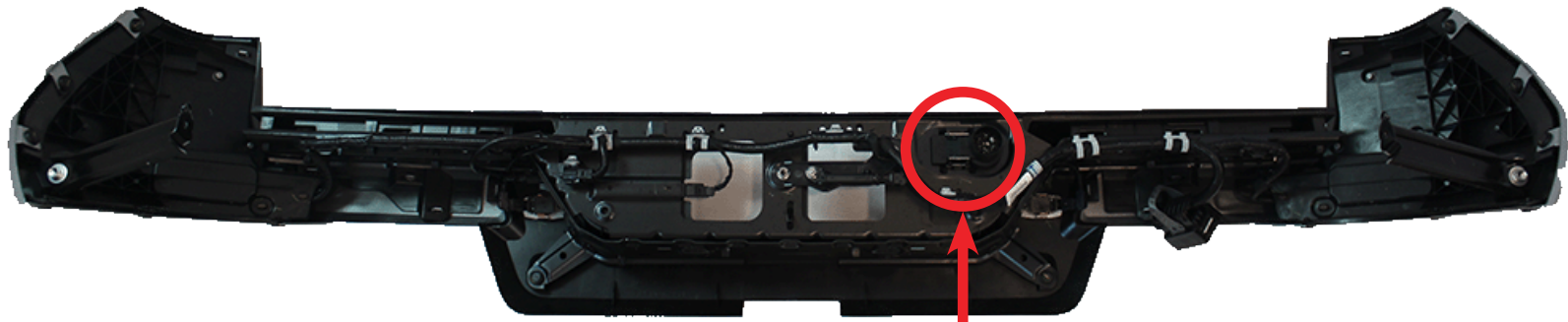

STEALTH REAR BUMPER 2024/TOYOTA TACOMA

REMOVAL

□ STEP 14

Remove the license plate light using a (flathead screwdriver) to release clips as shown below.

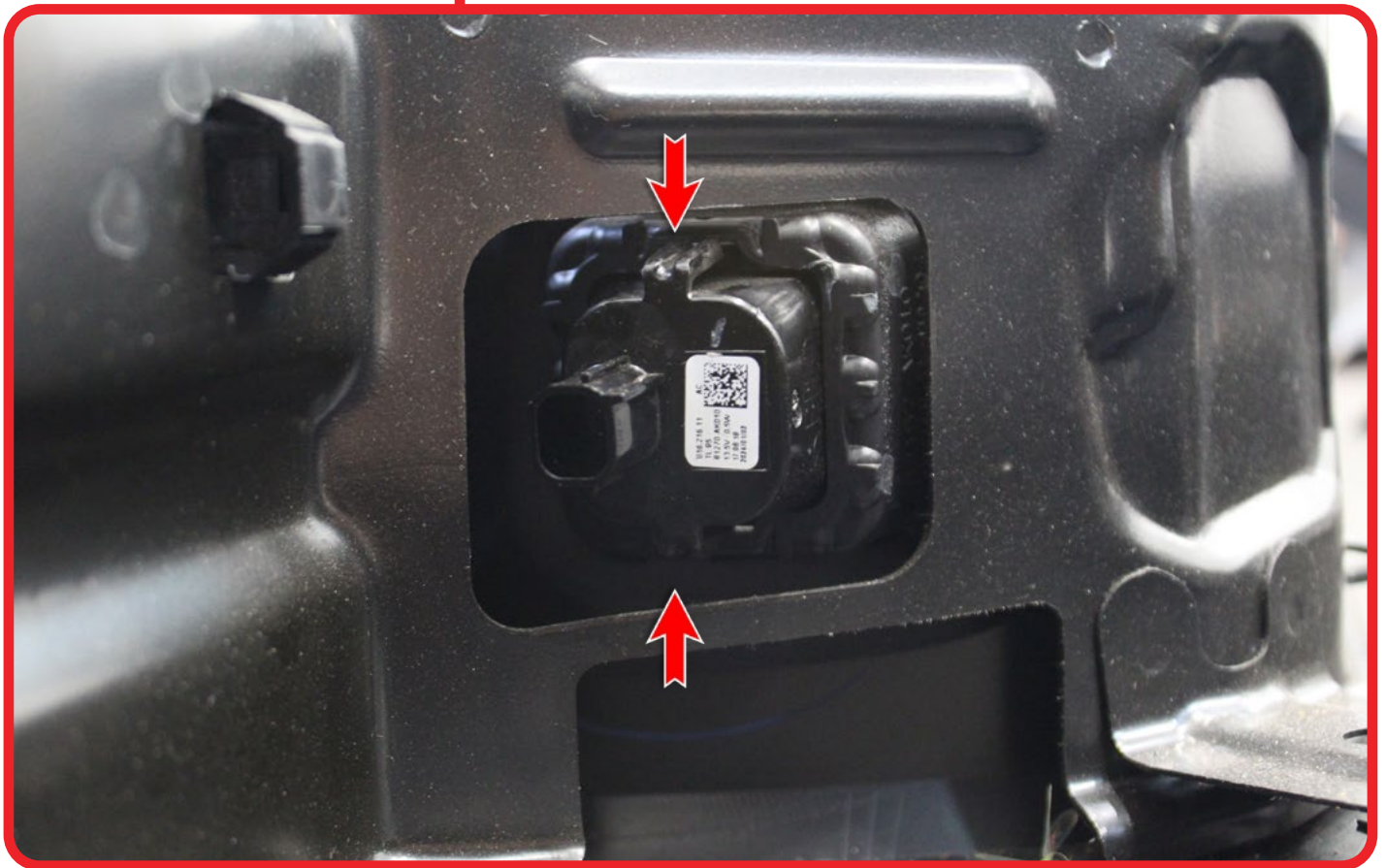
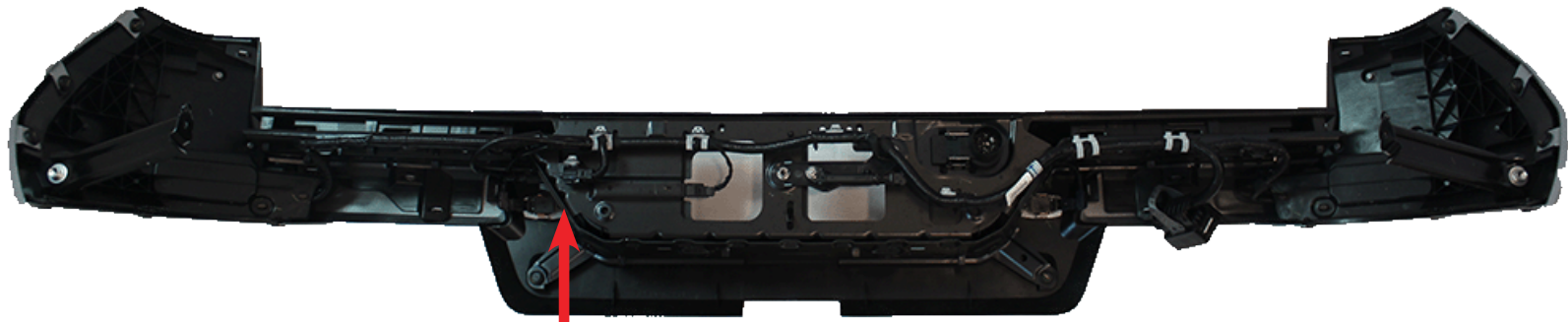

STEALTH REAR BUMPER 2024/TOYOTA TACOMA

REMOVAL

STEP 15

Using a (10mm socket), Remove the 6x blind spot sensor nuts.

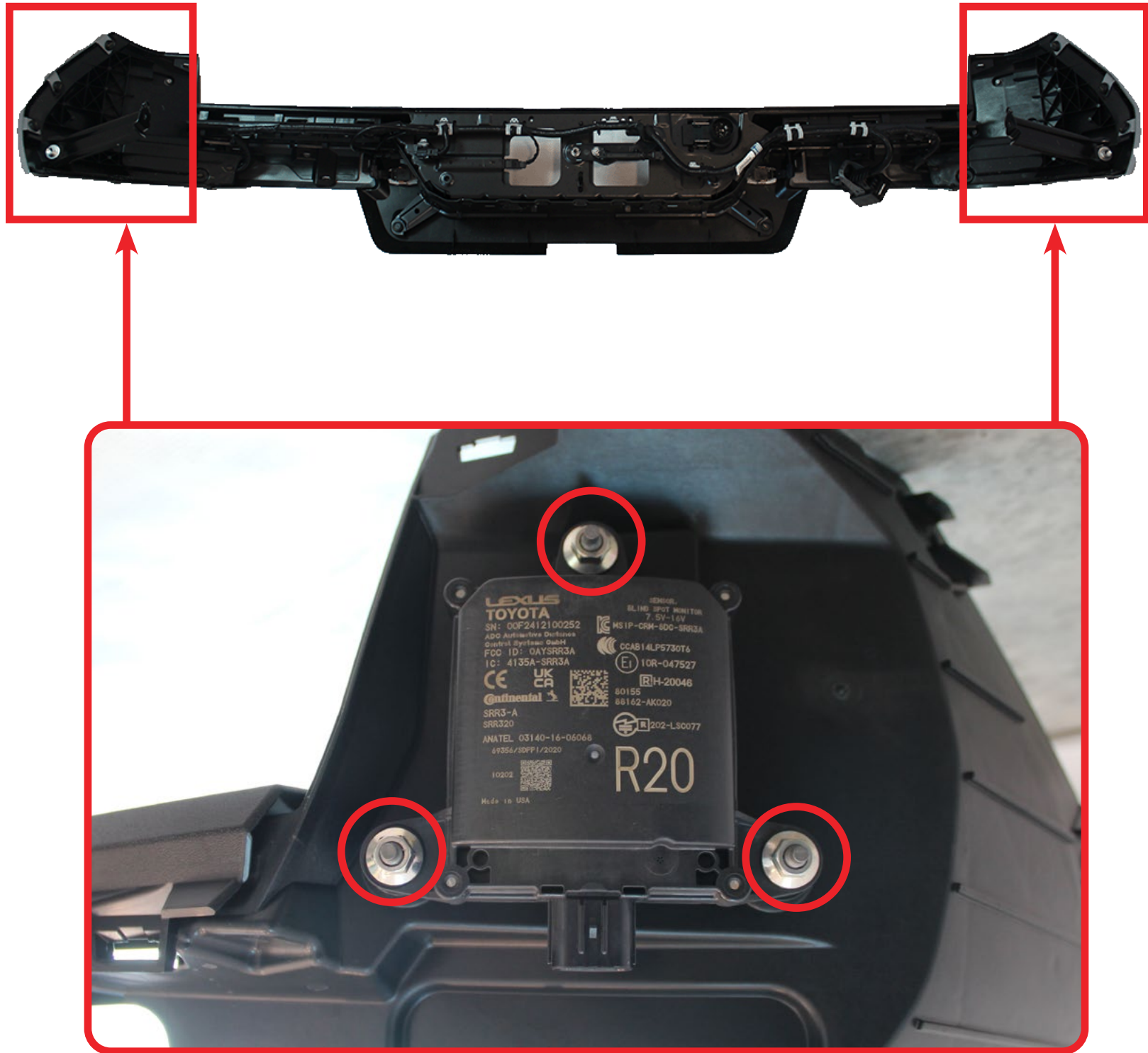

STEALTH REAR BUMPER 2024/TOYOTA TACOMA

REMOVAL

□ STEP 16

Using a (grinder), Grind off the studs located center of the hitch as shown below and apply (black spray paint) to prevent rust.

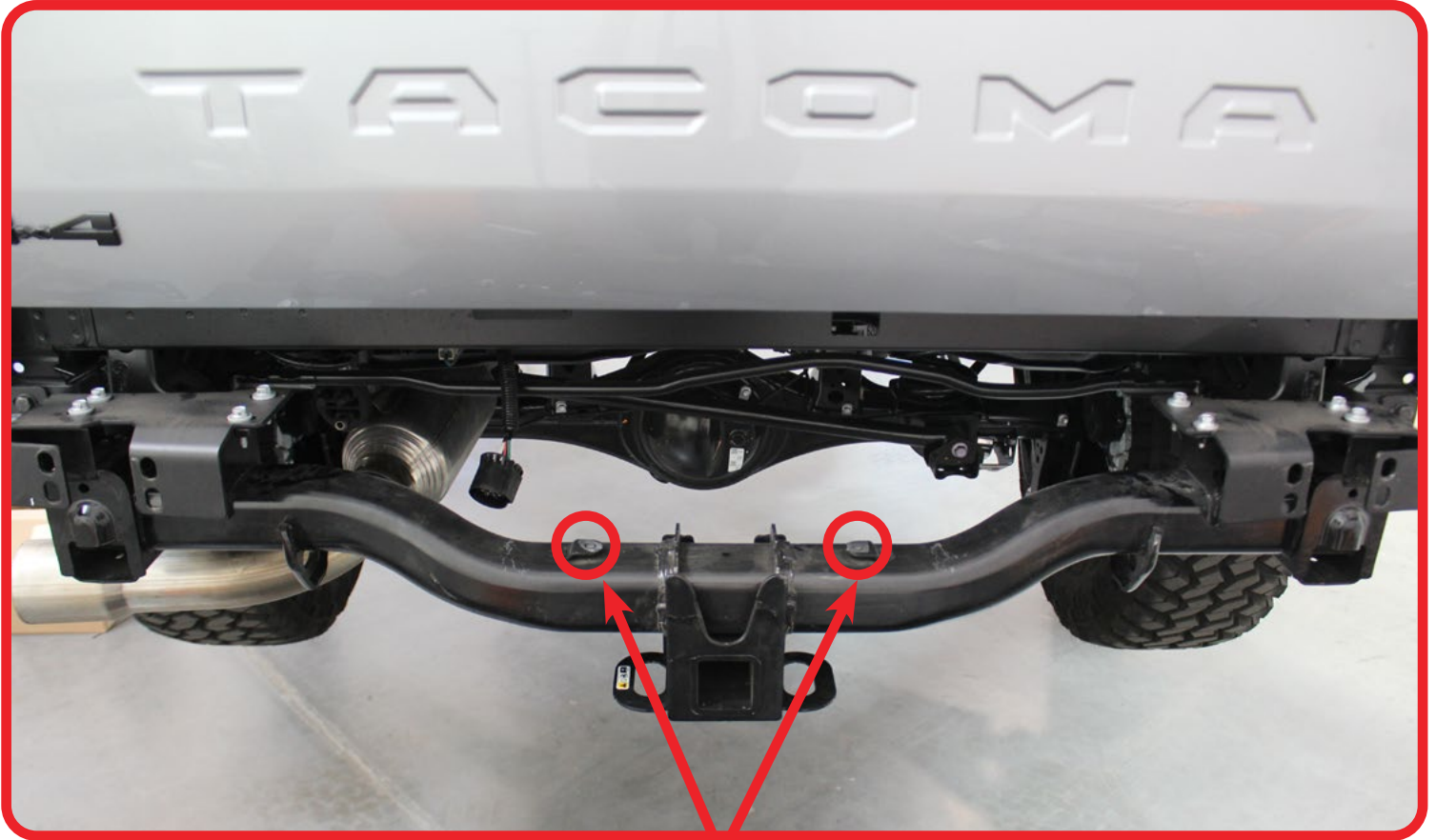

STEALTH REAR BUMPER 2024/TOYOTA TACOMA

REMOVAL

□ STEP 17

Using a (flathead screwdriver), Remove the plastic caps located on the side of the frame rails as shown below.



STEALTH REAR BUMPER 2024/TOYOTA TACOMA

INSTALL

□ STEP 18

Install the mounting brackets using a (12mm Socket) with the OEM hardware removed from steps 3 & 5.

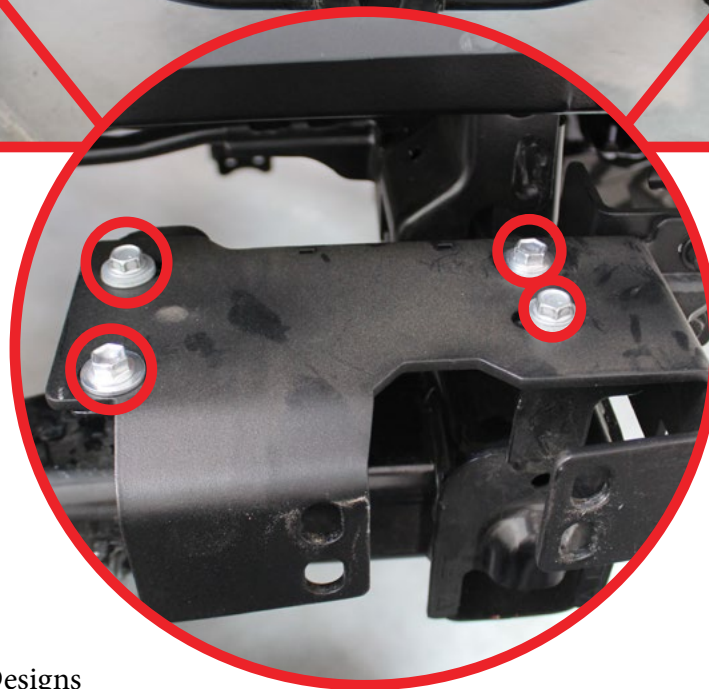
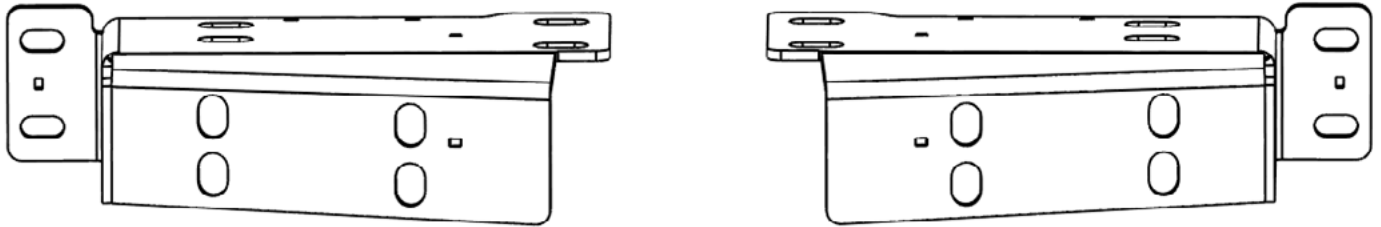

STEALTH REAR BUMPER 2024/TOYOTA TACOMA

INSTALL

□ STEP 19

Install the support brackets as shown below with the provided **(B, B4, B5)** 3/8" hardware using a (9/16 socket) and a (9/16 wrench).

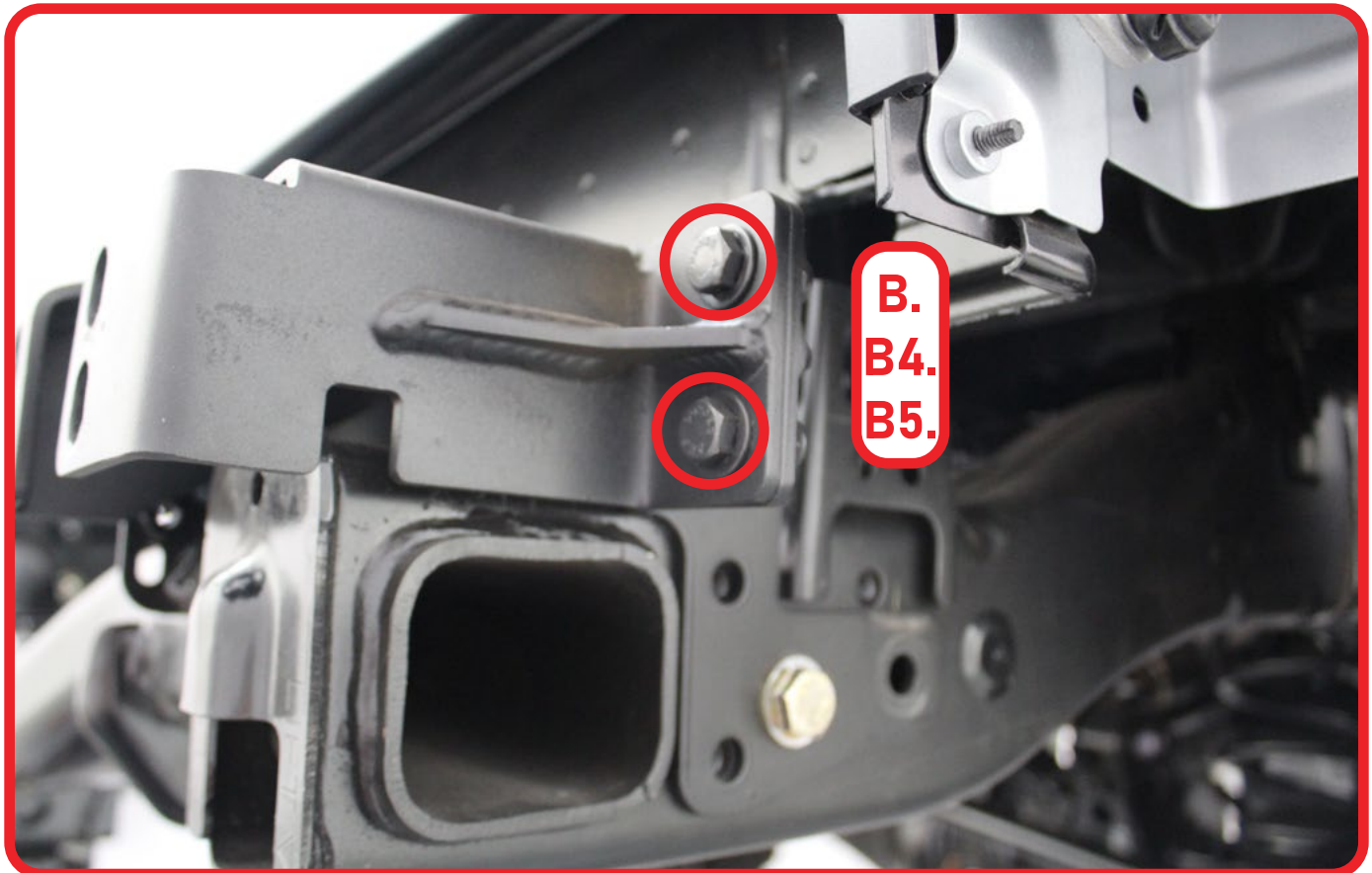
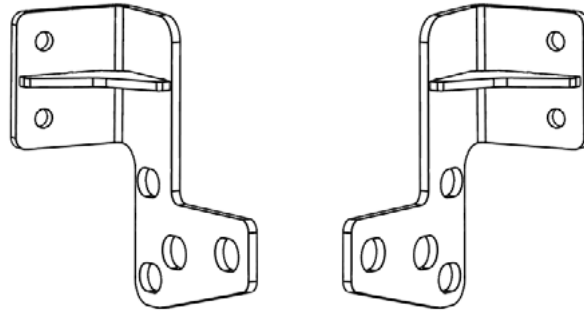

STEALTH REAR BUMPER 2024/TOYOTA TACOMA

INSTALL

□ STEP 20

Using a (3/4 socket) and a (3/4 wrench), install the provided (C, C1, C2) 1/2" hardware through the capped holes from **step 17** using the provided backer plate on the inside as shown below. (Leave the one bolt on each side out for later)

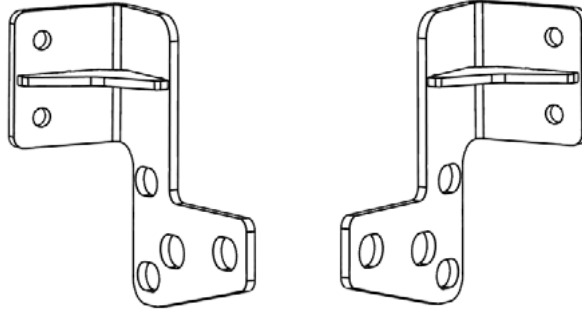

STEALTH REAR BUMPER 2024/TOYOTA TACOMA

INSTALL

□ STEP 21

Remove double sided tape from the bezel until the surface is clear of residue.

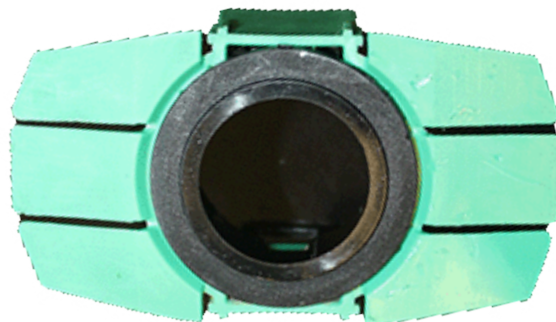

STEALTH REAR BUMPER 2024/TOYOTA TACOMA

INSTALL

□ STEP 22

Install the provided (F) 3m double sided tape to each side of the bezel wings and trim excess with a (razor blade).

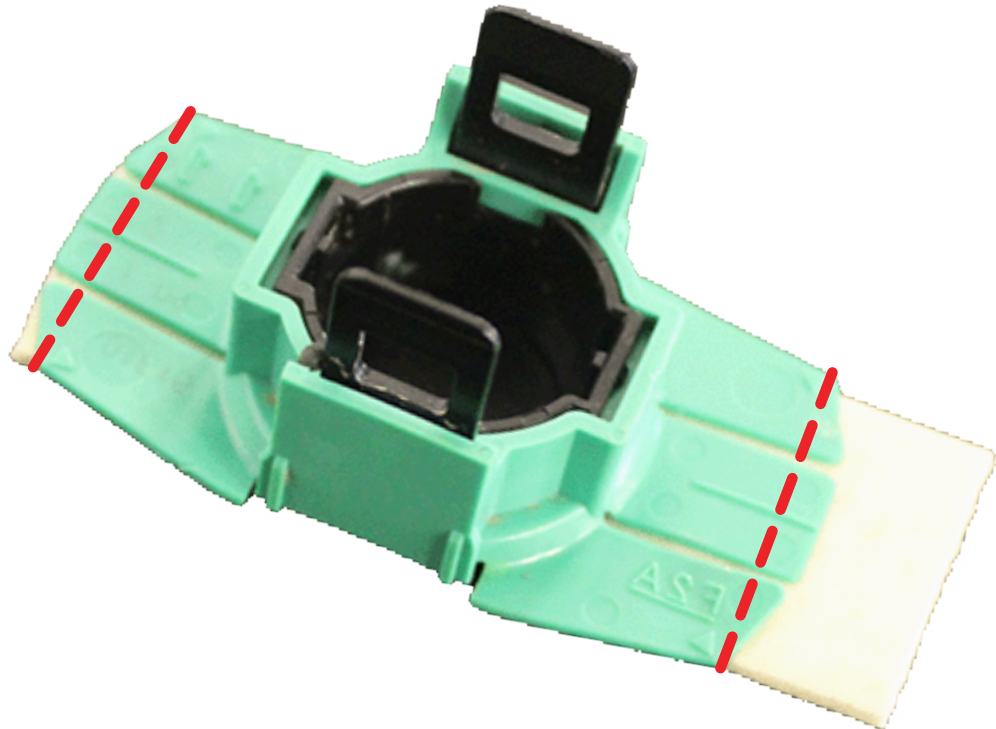
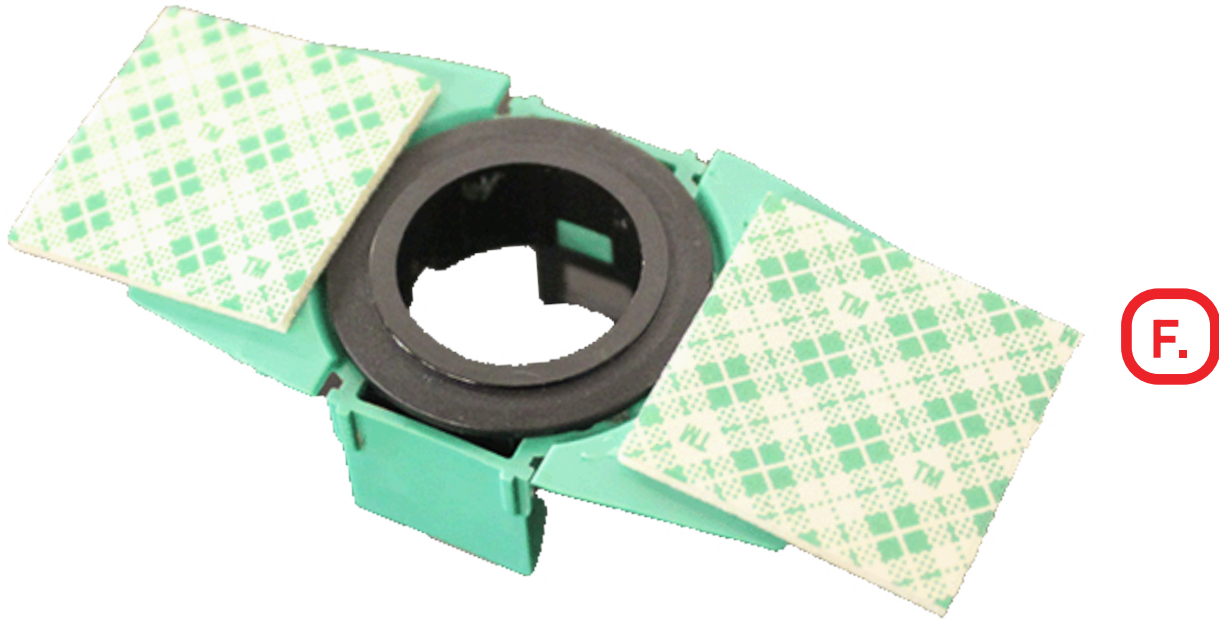

STEALTH REAR BUMPER 2024/TOYOTA TACOMA

INSTALL

□ STEP 23

Install the sensor bezels in the orientation shown below.



STEALTH REAR BUMPER 2024/TOYOTA TACOMA

INSTALL

□ STEP 24

(Optional) Using (black spray paint), lightly paint over the sensor before installing.



STEALTH REAR BUMPER 2024/TOYOTA TACOMA

INSTALL

□ STEP 25

Using a (5/32 allen) and a (7/16 wrench), Install the blind spot sensors as shown below with the provided (A1, A2, A3) 1/4" hardware and the (E) spacers between the bumper and the sensor.

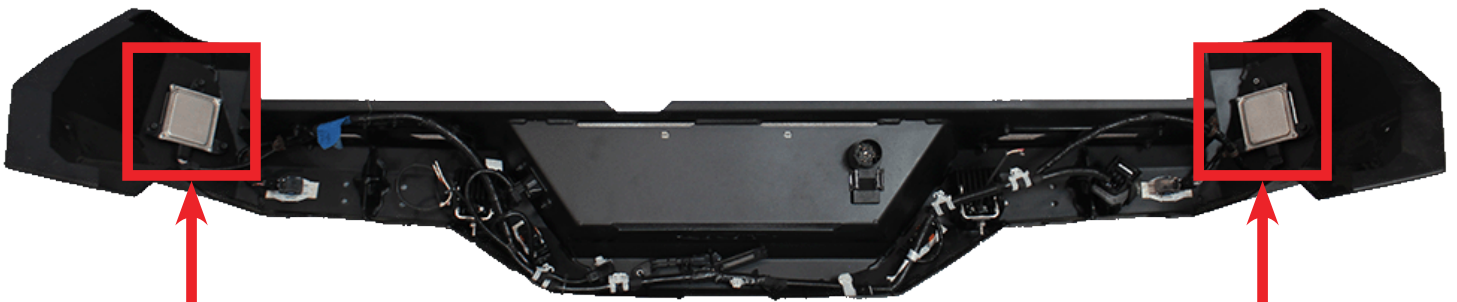

STEALTH REAR BUMPER 2024/TOYOTA TACOMA

INSTALL

□ STEP 26

Using a (flathead screwdriver), Install the trailer plug by prying out the tabs as shown below.

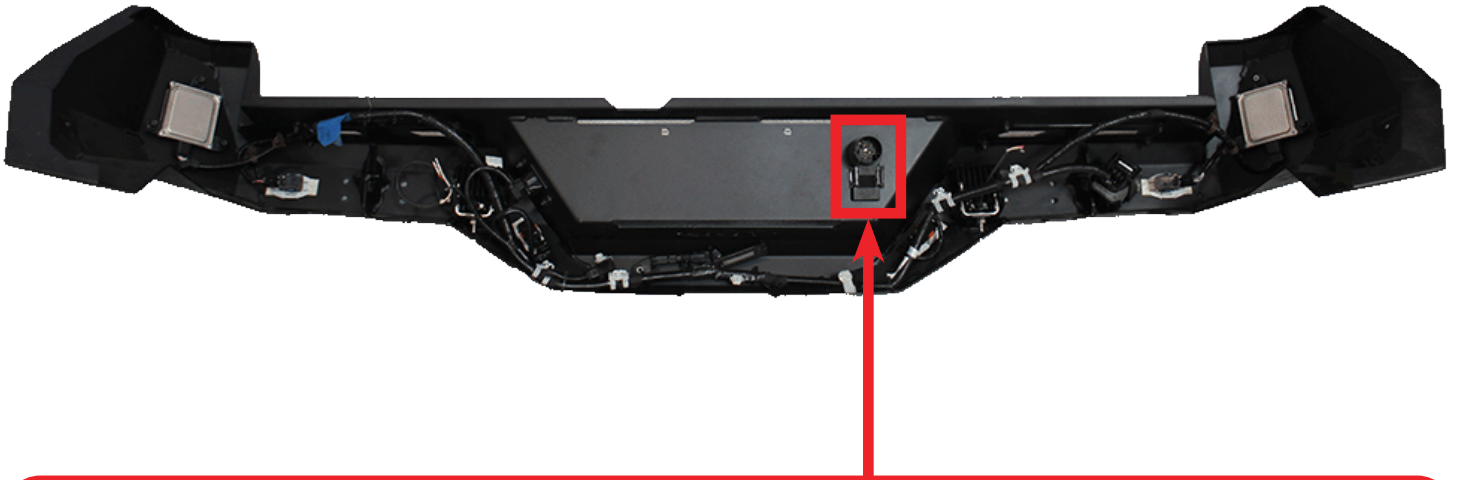

STEALTH REAR BUMPER 2024/TOYOTA TACOMA

INSTALL

□ STEP 27

Using a (5/32 allen) and a (7/16 wrench), Install the license plate light with the provided (A, A2, A3) 1/4" hardware.

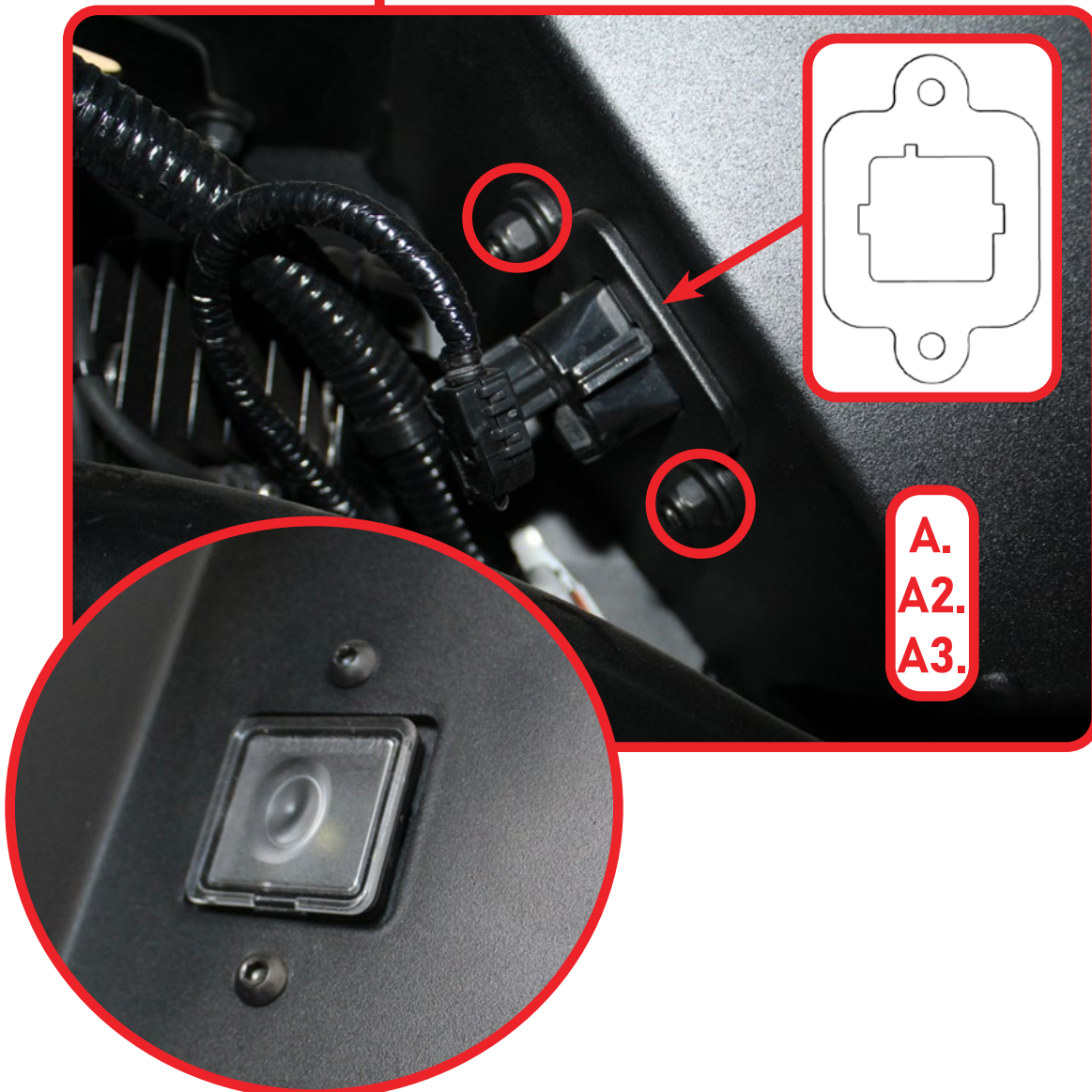

STEALTH REAR BUMPER 2024/TOYOTA TACOMA

INSTALL

□ STEP 28

Install the provided (B3) u-nut clips to the mounting plates as shown below. Next, with a helping hand, one person hold the bumper to the truck while the other inserts the mounting plates behind the bumper as shown in **fig 1**.

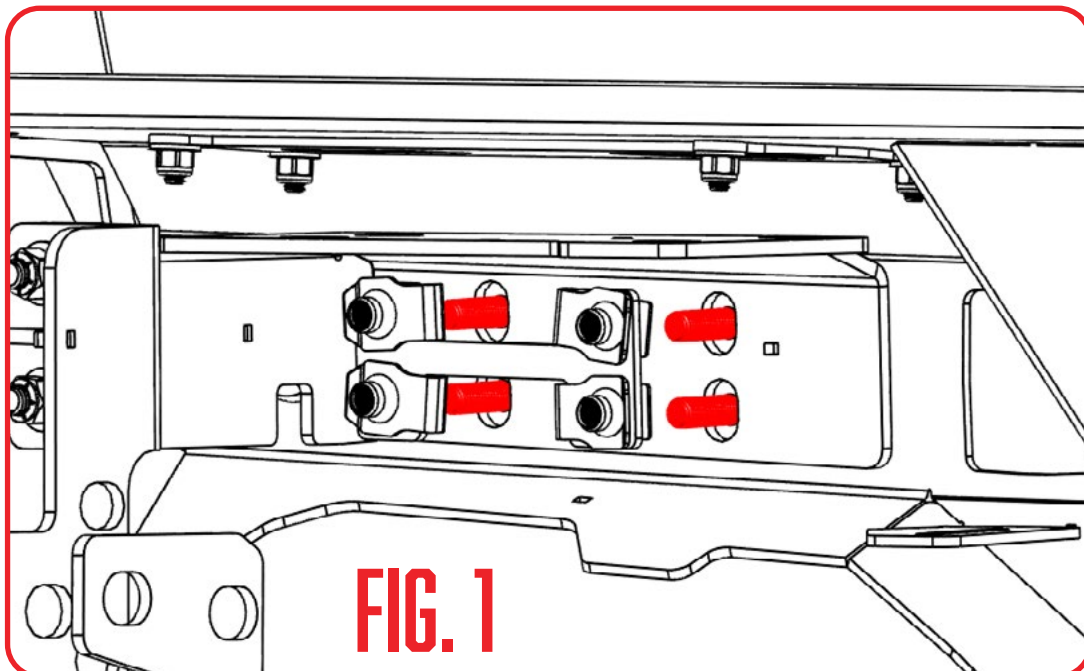
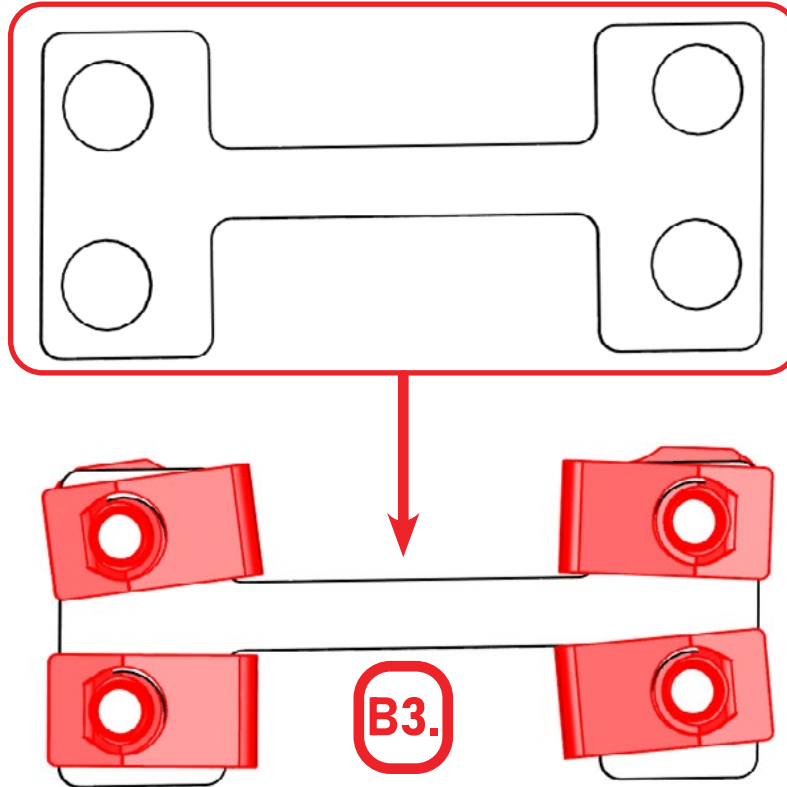

STEALTH REAR BUMPER 2024/TOYOTA TACOMA

INSTALL

□ STEP 29

Install the bumper using a (7/32 allen) with the provided **(B2)** 3/8" hardware into the mounting plates installed on step 28.



STEALTH REAR BUMPER 2024/TOYOTA TACOMA

INSTALL

□ STEP 30

Using a (9/16 socket) and a (9/16 wrench), assemble the side support brackets with the provided (B, B4, B5) 3/8" hardware as shown below. ****Keep loose for adjustments****

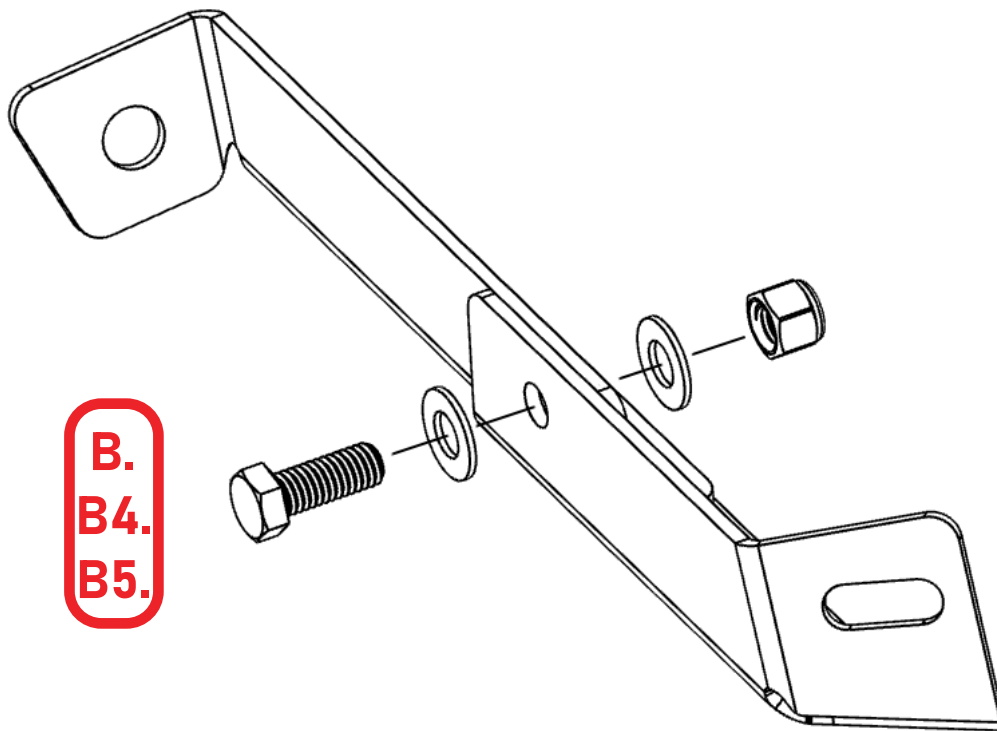

STEALTH REAR BUMPER 2024/TOYOTA TACOMA

INSTALL

□ STEP 31

Install the side support brackets using a (3/4 Socket) and a (3/4 wrench) in the mounting holes from step 20 shown in **fig 2** with the provided **(C, C1, C2)** 1/2" hardware. Install the provided **(B1, B4, B5)** 3/8" hardware with a (7/32 allen) and a (9/16 wrench) as shown in **fig. 3**.

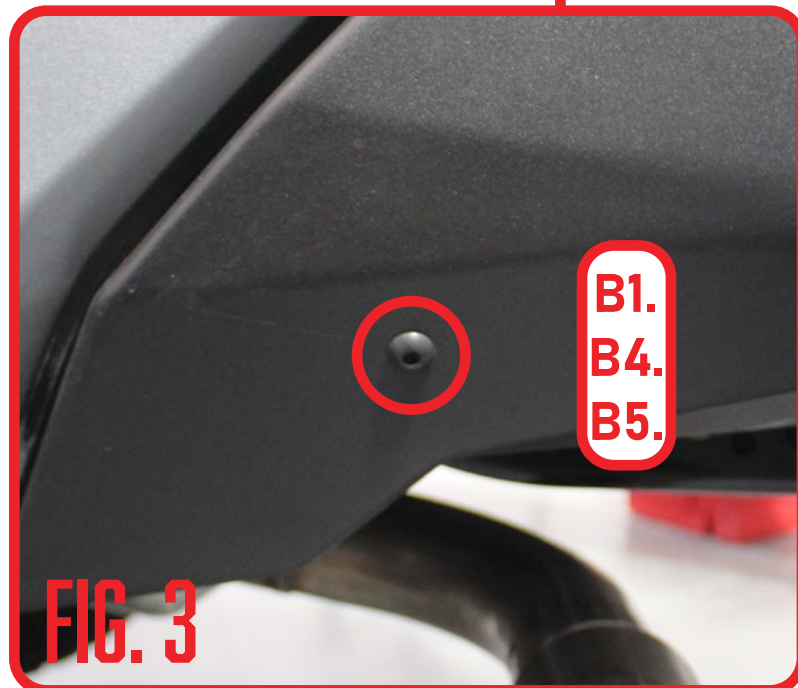

STEALTH REAR BUMPER 2024/TOYOTA TACOMA

INSTALL

□ STEP 32

Plug in the main wiring harness.

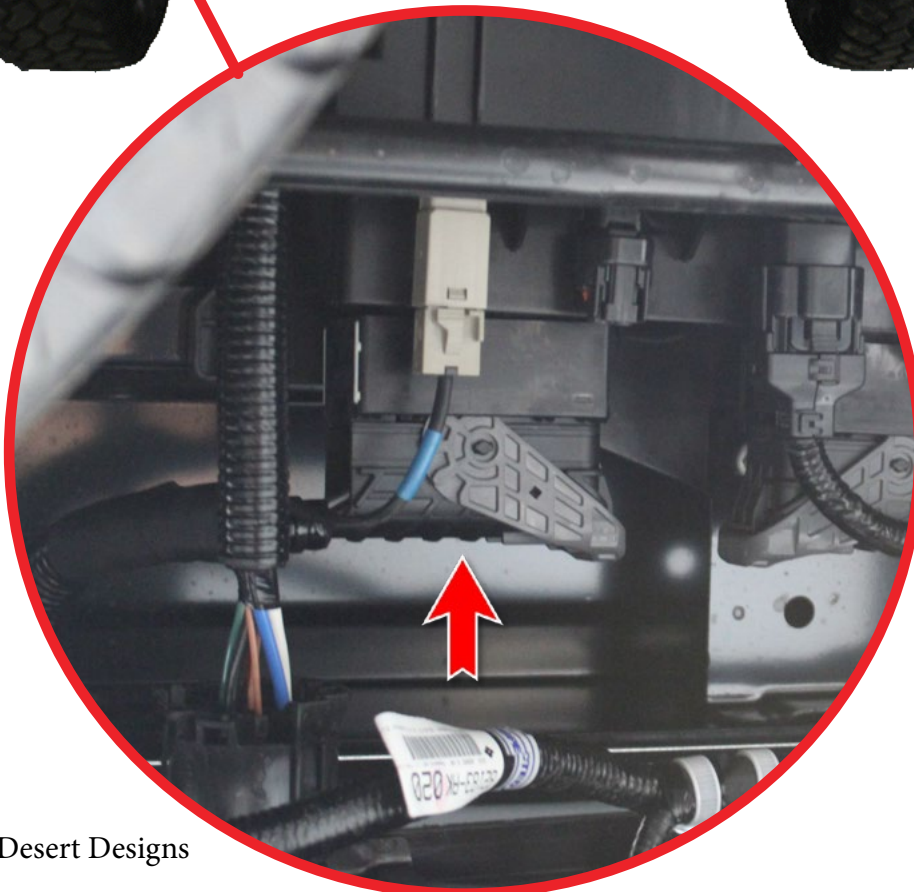

STEALTH REAR BUMPER 2024/TOYOTA TACOMA

INSTALL

□ STEP 33

Plug in the trailer plug.



STEALTH REAR BUMPER 2024/TOYOTA TACOMA

INSTALL

□ STEP 34

Install the license plate with the provided (D, D1) hardware using a (10mm socket).

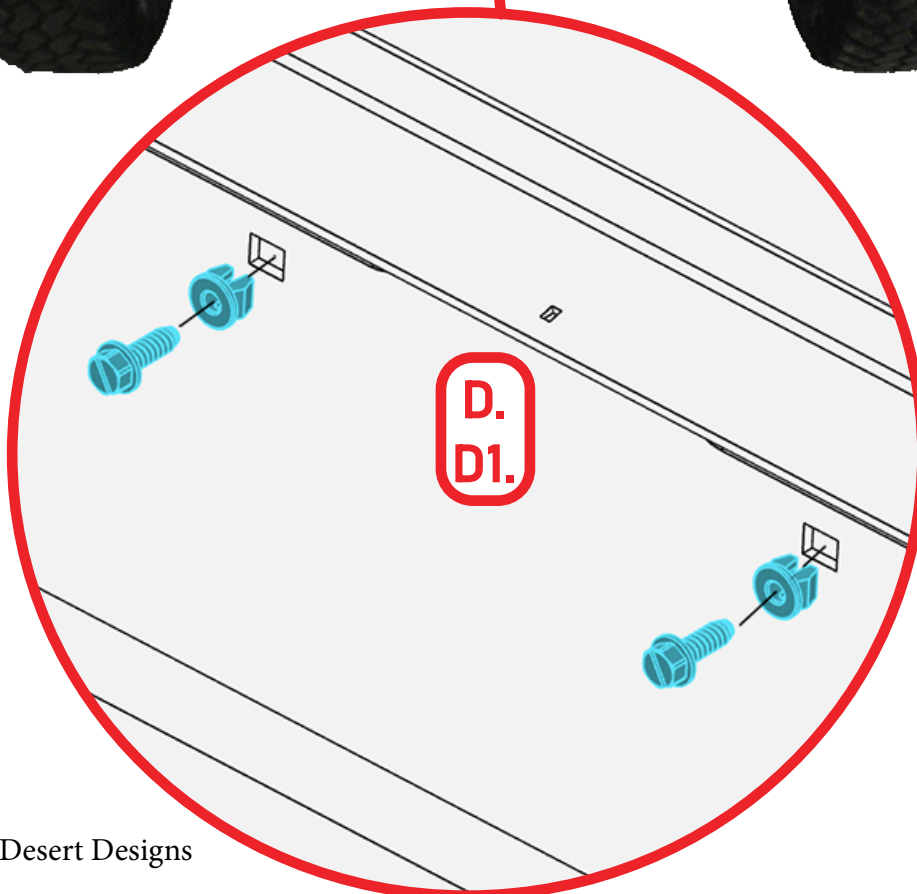

STEALTH REAR BUMPER 2024/TOYOTA TACOMA

FINAL

STEP 35

Stand back and enjoy your new ADD Stealth Rear Bumper.

Check and re-tighten, if needed, all mounting bolts after 100 miles and periodically thereafter.



THIS PRODUCT IS PROTECTED BY ONE OR MORE U.S. PATENTS
WWW.ADDICTIVEDESERTDESIGNS.COM/PATENTS

FOR ADDITIONAL SUPPORT OR TECHNICAL QUESTIONS,
PLEASE CALL 480-671-0820 OR
EMAIL INFO@ADDICTIVEDESERTDESIGNS.COM